

ROYAL ENFIELD OWNER'S MANUAL

USA/CALIFORNIA



FOREWORD

Congratulations. You now own a piece of history!

It's not only a machine but an ode to the glorious past - The Café Racer.

An evolution of the Royal Enfield Continental GT 535, which, in turn was an evolution of the Continental GT 250 - the original Royal Enfield British café racer - the Continental GT 650 Twin is every bit like its predecessor, only much better.

Designed to be simple and robust with solid and precise engineering, the Continental GT has been built to be your faithful companion on rides and adventures, big and small. Powered by our brand-new air-cooled 648cc twin cylinder engine and robust twin cradle chassis developed at our state-of-the-art tech centre in the United Kingdom, we hope you enjoy riding your motorcycle as much as we enjoyed building it for you.

This manual is your friend, philosopher, and guide when it comes to taking care of your motorcycle. In the pages that follow, you will find ways of looking after your machine so that it remains a reliable partner in your travels and exploration for decades to come.

Please do avail of all the services at your nearest Royal Enfield Authorised Service Centre to make sure that your motorcycle gets the right treatment which it so deserves. Please also read through the terms and conditions of warranty and other useful information in this manual before riding off into the sunshine.

Keep riding pure.

To know more about Royal Enfield, our products, and other news, go to www.royalenfield.com

NOTICE

All information in this manual is based on the latest product information available at the time of publication. Due to continuous improvements, there may be discrepancies between the information in this manual and your motorcycle.

Royal Enfield reserves the right to make production changes at any time without prior notice and without incurring any obligation to make the same or similar changes to motorcycle previously built or sold.

"© Copyright 2019 Royal Enfield (A unit of Eicher Motors Ltd.). All Rights Reserved. No part of this manual shall be copied, distributed or otherwise dealt without the express permission in writing from Royal Enfield".

All images shown are for reference to explain and need not to be exactly the same on the model you own. Technical specifications are subject to change without prior notice.

Disclaimer

- This model fitted with "tubeless Tire" is provided with an inner tube.
- Failure to use an inner tube in a spoked wheel will cause deflation of the Tire resulting in loss of motorcycle control.
- The approved Tires marked with "TUBELESS" are suitable for use with inner tube.

Toll free no : 1-866-600-1122

E mail ID : U.Scustomerservice@royalenfield.com

Part No. RAM00095/A / Qty. 300 / Jan. '19

IMPORTANT

United States Environment Protection laws, Federal Motor Vehicle Safety Standards and California Air Resources Board (Applicable only for motorcycles sold within the state of California.) strictly prohibits tampering with the Exhaust Emission Control, Noise Control and Evaporative Emission Control systems:

We would like to emphasize that any repairs to the induction, emission, exhaust and evaporative systems must be performed only by a Royal Enfield Authorized Dealer so that the motorcycle conforms to the United States Environment Protection laws, Federal Motor Vehicle Safety Standards and California Air Resources Board regulation (Applicable only for motorcycles sold within the state of California.)

It is the responsibility of the Owner / User of the motorcycle to read this manual carefully and to comply with the safety guidelines, operating instructions, and periodical maintenance instructions given here. Keep this manual in a convenient place for easy reference. DO NOT use the motorcycle until you have become familiar with this motorcycle and after reading and understanding this manual completely. In case you need any further clarifications, please contact a Royal Enfield Authorized Dealer, nearest to you, for assistance.

If your motorcycle is being used by a friend, relative, or any other person, it is your responsibility to make certain that they have completely understood the operating procedures of the motorcycle, and the contents in this manual with particular reference to the safety aspects, before riding your motorcycle.

This motorcycle is designed for NORMAL ON ROAD USE ONLY. Operation in off-road usage in some areas may be illegal and could be dangerous. Please obey local laws and regulations.

In the event of your motorcycle being sold to another person, it is your responsibility to hand over this manual along with the motorcycle to the new owner.

REPORTING SAFETY DEFECTS

If you believe your motorcycle has a defect which could cause a crash and result in serious injury or loss of life, you should immediately contact the National Highway Traffic Safety Administration (NHTSA) in addition to notifying Royal Enfield North America Limited, 226 N Water St., Milwaukee WI 53202 US.

If NHTSA receives similar complaints, it may open an investigation and if it finds that a safety defect exists in a group of vehicles, it may order a recall and remedy campaign. However, NHTSA cannot become involved in any individual problems between you, and your dealer or Royal Enfield North America Limited.

To contact NHTSA you may call the Auto Safety Hotline toll-free within the United States on 1-800-424-9393 or write to: NHTSA, 400 Seventh Street SW, Washington, DC 20590. You can also obtain other information about motor vehicle safety from the hotline.

CONTENTS

Safety Definitions	7
Personal and Motorcycle Information	8
Safe Riding Tips / Guidelines	9
Rules of the Road	15
Accessories and Luggage.....	18
Technical Specifications	20
Recommended Lubricants	28
Motorcycle Identification Numbers	30
Engine Number Details	32
Location of Key Parts	33
Operation of Controls	36
Warning Indications and Safety Systems	47
Pre-Operational Checks	52
Running in Period.....	53
Starting.....	55
Gear Shifting, Riding and Stopping	59

CONTENTS

Parking	63
Tools Kit	65
Minor Maintenance Tips	66
Long Trip Precautions	103
Washing Procedure	105
Storage Precautions	107
Trouble Shooting	108
Wiring Diagram	116
Periodical Maintenance Chart	119
Service Maintenance Record	123
Warranty Terms and Conditions	125
Emission Control System Warranty	128
Noise Control System Warranty	130
EVAP	132
Environment Care	134
Notes	136

SAFETY DEFINITIONS

The information given under the titles: Warning, Caution and Note are for your safety and for the care and safety to your motorcycle and others. Please read these carefully and if disregarded may result in injury to yourself or others and damages to the motorcycle.



WARNING

Indicates a potentially hazardous situation. Disregarding this message may result in injury to rider or other persons.

CAUTION

This message, if disregarded, may result in damage to the motorcycle.

NOTE

Indicates important and useful messages for better understanding.

SAFERIDING TIPS / GUIDELINES

- Before operating your new motorcycle, we request you to carefully read and follow the operating and maintenance instructions detailed in this manual for the safety of your own, your motorcycle, and also that of others.
- Know and adhere to the rules of the road with respect to your driving country.
- Before starting the motorcycle, check for proper operation of brakes, clutch, gear shifter, handle bar controls, Tire pressures, fuel and oil levels, etc.
- Use only genuine Royal Enfield spare parts and approved accessories. Use of other manufacturer's parts may affect the performance of your motorcycle and render the motorcycle void of warranty. Visit your Royal Enfield Authorized Service Centre for details.
- Whenever refueling your motorcycle, please exercise utmost caution and carefully observe the following guidelines.
 - ★ Refuel in a well ventilated area with the engine turned off condition.
 - ★ Open the fuel filler cap slowly.
 - ★ Switch OFF mobile phones and other hand held electronic devices.
 - ★ DO NOT smoke and please ensure that there are no open flames or sparks near the motorcycle, when refuelling OR servicing the fuel system.

SAFERIDING TIPS / GUIDELINES

- ★ DO NOT fill the tank to its brim. Please fill fuel till the bottom of anti splash plate, so as to leave sufficient air space in the fuel tank to allow for fuel expansion.



WARNING

Royal Enfield cautions you against the use of certain nonstandard parts such as aftermarket and custom made extended front forks or suspensions, which may adversely affect performance and handling. Removing or altering original parts may adversely affect performance and could result in accident.

- A new motorcycle must be operated according to the special running-in-procedure. See running-in-procedure mentioned in respective section.
- Operate motorcycle only at moderate speeds and out of traffic until you have become thoroughly familiar with its operation and handling characteristics under all conditions.
- DO NOT exceed the legal speed limit or ride too fast for existing conditions. Always reduce speed when poor riding conditions exist. High speed increases the influence of any other condition affecting stability and increases the possibility of loss of control.

SAFERIDING TIPS / GUIDELINES

NOTE

If you are an inexperienced rider we recommend that you obtain formal training on correct motorcycle riding techniques and become thoroughly familiar with the operation of your motorcycle. New riders should gain experience under various conditions while driving at moderate speeds.

Pay strict attention to road surfaces and wind conditions. Any motorcycle may be subject to the following upsetting forces:

- ★ Wind blasts from passing vehicles.
- ★ Rough or uneven road surfaces.
- ★ Slippery road surfaces.

These forces may affect the handling characteristics of your motorcycle. If this happens, reduce speed of the motorcycle to a controlled condition. Do not apply brake abruptly.

- Operate your motorcycle defensively. Remember that a motorcycle does not afford the same protection as an automobile in an accident. One of the most common accident situations occurs when the rider / driver of the other motorcycle / vehicle fails to see or recognise a motorcycle and turns into the oncoming motorcyclist.

SAFERIDING TIPS / GUIDELINES

- Wear an approved helmet, clothing, and footwear suited for riding a motorcycle. Bright/light colours are best for greater visibility in traffic, especially at night. Avoid loose, flowing garments and scarves.
- When carrying a pillion rider, it is your responsibility to instruct them on proper riding procedures.
- DO NOT allow other individuals, under any circumstances, to operate your motorcycle unless you know they are experienced, licensed riders and are thoroughly familiar with the operating conditions of your motorcycle.



WARNING

Regularly inspect shock absorbers and front forks and look for leaks. Replace worn out parts. Worn out parts can adversely affect stability and handling.



WARNING

For your personal welfare, all the listed service and maintenance recommendations should be performed. Lack of regular maintenance at the suggested intervals may affect the safe/durability/longevity operation of your motorcycle.

SAFE RIDING TIPS / GUIDELINES

 **WARNING**

Avoid any contact with the exhaust system when hot. Wear clothing that will completely cover the legs while riding. The exhaust system gets very hot when the engine is running and remains too hot to touch, even after the engine is turned off. Failure to wear proper or protective clothing could result in serious injury.

 **WARNING**

Exhaust gas contains poisonous carbon monoxide and chemicals, known to cause cancer, birth defects or other reproductive defects.

 **WARNING**

Motorcycle batteries contain lead, acids and chemicals known to cause cancer, birth defects or other reproductive harm. Exercise extreme caution while handling a battery, wash hands thoroughly whenever a battery is handled.

SAFE RIDING TIPS / GUIDELINES



WARNING

Consult your Royal Enfield Authorized Service Centre regarding any questions or problems that occur in the operation of your motorcycle. Failure to do so may aggravate an initial problem, cause costly repairs and jeopardize your personal safety.



WARNING

DO NOT tow a motorcycle. The steering and handling of the towed motorcycle will be impaired due to the force of the towline. If a motorcycle must be transported, use a truck or a trailer.



WARNING

DO NOT pull a trailer behind a motorcycle. Towing a trailer may cause reduced braking efficiency, Tire overloading and unstable handling, as it may cause loss of control of the motorcycle in the front, leading to an accident.

RULES OF THE ROAD

- Be sure your number plate is installed in the position specified by law and it is clearly visible at all times.
- Ride at a safe speed that is consistent with the type of road surface you are on. Pay strict attention while riding on the following surfaces :
 - ★ Dusty
 - ★ Oily
 - ★ Icy
 - ★ Wet
 - ★ Sand
- Watch for loose debris, such as leaves, slippery substances or gravel that can hamper the stability of your motorcycle.
- Keep to the correct side of the road centre line when meeting oncoming vehicles.

RULES OF THE ROAD

- Actuate your turn signals and exercise caution when passing other vehicles going in the same direction. Never try to pass another vehicle going in the same direction at street intersections, on curves, or when going up/or down a hill.
- At street intersection give the right-of-way to the motorcycle on your left or right. DO NOT presume you have the right-of-way.
- Adhere to the rules of the road with respect to your country when preparing to stop, turn or pass. While turning either right or left, watch for pedestrians, animals, as well as other vehicles.
- All traffic signs, including manual controls at intersections, should be obeyed promptly. SLOW DOWN at traffic signs near schools and CAUTION signs at railroad crossings.
- When intending to turn, signal at least 100 feet (30.5 meters) before reaching the turning. Be close to the centre line (unless local rules require otherwise), slow down and then turn carefully.
- Never jump a traffic light. When a change is imminent from GO to STOP (or vice versa) at intersections, slow down and wait for the light to change to green. Never run through a yellow or red traffic light.
- DO NOT leave the curb or parking area without signalling. Be sure your way is clear to enter moving traffic. A moving line of traffic always has the right-of-way.

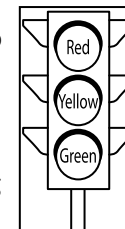

RULES OF THE ROAD

- When parking the motorcycle, park on a firm and flat surface to prevent it from falling over.
- Protect your motorcycle against theft. After parking your motorcycle, ensure that the steering head is locked and then remove the ignition key.

SIDE VIEW MIRRORS

Your motorcycle is equipped with convex mirrors and have a curved surface. This type of mirror is designed to give a much wider view of the rear than a normal flat mirror. However, vehicles and other objects seen in this type of mirror will look smaller and farther away than when seen in a flat mirror.

Use care when judging the size or distance of vehicles / objects seen in these mirrors.

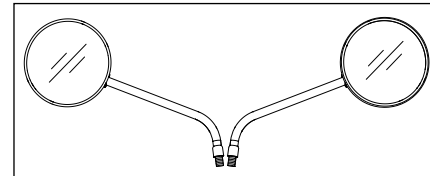

NOTE

To establish the relative distance of vehicles / objects behind your motorcycle through the mirrors, adjust each mirror in such a way, that a small portion of your shoulder is visible and a large portion behind your motorcycle is seen clearly with reference to your riding posture.

ACCESSORIES AND LUGGAGE

Royal Enfield offers a range of Genuine Motorcycle Accessories that have been fully approved and extensively tested alongside the motorcycle.

Therefore, the rider must be responsible for safe operation of the motorcycle when installing accessories or carrying additional weight. (Max. payload: 200 kg)

Please adhere to the following guidelines when carrying a pillion, luggage or when fitting any accessories.

- DO NOT exceed 110km/h / 70 mph when riding solo, carrying a pillion or payload on an accessory equipped motorcycle.
- Keep luggage weight concentrated close to the motorcycle and as low as possible; this minimizes sudden shift in the motorcycle's centre of gravity.
- Distribute weight evenly on both sides of the motorcycle.
- DO NOT load bulky items behind the rider or add weight to the handlebars or front forks.
- DO NOT exceed 6.6 pounds (3 kgs) maximum weight in each Royal Enfield Genuine motorcycle accessory pannier.
- Re-check the luggage periodically to ensure it is secured and will not shift while riding. Accessories mounted loosely may affect the riding of the motorcycle and affect the handling and stability of the motorcycle.
- Large surfaces such as fairings, windshields, backrests and luggage racks can adversely affect handling of the motorcycle. Use Royal Enfield Genuine Motorcycle Accessories which are model specific and follow installation procedure.

ACCESSORIES AND LUGGAGE

 **WARNING**

DO NOT load weight or install accessories incorrectly on the motorcycle. Doing so may affect the motorcycle's stability, handling characteristics and safe operation and could result in an accident causing serious injury or loss of life.

 **WARNING**

Royal Enfield offers a range of Genuine Motorcycle Accessories that have been fully approved and extensively tested alongside the motorcycle.

 **WARNING**

Royal Enfield cautions you against use of nonstandard parts such as aftermarket and custom made extended front forks which may adversely affect the performance and handling of the motorcycle. Removing or altering original parts may adversely affect the performance of the motorcycle, causing an accident, which could result in serious injury or loss of life.

 **WARNING**

DO NOT ignore model / design specifications. Doing so constitutes both motorcycle and accessories misuse which may adversely affect the handling and performance of the motorcycle causing an accident, which could result in serious injury or loss of life.

TECHNICAL SPECIFICATIONS

ENGINE

Engine Type	Inline Twin Cylinder, 4 Stroke, SOHC
Bore	78mm
Stroke	67.8mm
Swept volume	648cc
Compression ratio	9.5:1
Max Power	34.9 kw @ 7250 rpm
Max Torque	52.3 Nm @ 5150 rpm
Idle RPM	1200±80 RPM
Starting	E-Start
Air filter element	Paper element
Lubrication	Forced lubrication, Wet sump with pump driven oil delivery
Gear Box	6 Speed Constant Mesh

TECHNICAL SPECIFICATIONS

Engine oil capacity	Dry Fill.....	4.12 quart / 3.9 Litre
	Refill.....	3.27 quart / 3.1 Litre
Engine oil grade		Fully synthetic 10W-50 to API SL (or higher) or JASO MA2, such as ELF MOTO4 TECH 10W 50
Fuel Supply		Fuel Injection
Cooling		Air cooling

IGNITION SYSTEM

Ignition		Digital Spark ignition
Ignition Advanced		11.25* BTDC
Spark Plug		BOSCH UR5CC
Spark Plug Gap		0.7 to 0.8 mm

TECHNICAL SPECIFICATIONS

TRANSMISSION

Clutch	Wet multiplate
Primary drive	Gear
Primary ratio	2.051 : 1
Gear box	6 Speed Constant Mesh
Gear Ratio	1 st 2.615:1
	2 nd 1.813:1
	3 rd 1.429:1
	4 th 1.190:1
	5 th 1:040:1
	6 th 0:962:1
Secondary drive	Sprockets and Chain (5/8" Pitch)
Secondary Ratio	2.533:1

TECHNICAL SPECIFICATIONS

CHASSIS

Frame	Steel Tubular, Double Cradle Frame
Suspension	
Front	41 mm Front Fork, 110 mm travel
Rear	Single Coil-over Shocks, 88 mm travel
Hydraulic Disc Brakes	Front and Rear with ABS system.
	Front: 320 mm disc, ABS
	Rear: 240 mm disc, ABS
	ABS: BOSCH 9.1
	Brakes: Dual Channel ABS
Brake Fluid:	Grade: DOT 4
	Capacity: Front: 0.05 quart Rear: 0.10 quart
Tire size:	
Front	100/90-18 M/C 56H Pirelli Phantom Sports Comp
Rear	130/70-18 M/C 63H Pirelli Phantom Sports Comp

TECHNICAL SPECIFICATIONS

Tire Pressure:

Solo

Front..... 32 psi/2.20 kg/cm²

Rear..... 36 psi/2.53 kg/cm²

With Pillion

Front..... 32 psi/2.20 kg/cm²

Rear..... 39 psi/2.74 kg/cm²

Steering Lock..... Combination Lock

Fuel Type Unleaded Gasoline

Ethanol content..... E10 or less

Minimum Octane Rating 91 RON (Research Octane Number) or Higher

Induction Fuel Injected

Fuel tank capacity 13.20* quarts / 12.5* litre

Low Fuel Warning 3.27* quarts / 3.1* litre

Dead Stock 1.58* quarts / 1.5* litre

* The above values are approximate and the actual fuel filling capacity will vary from the values mentioned.

TECHNICAL SPECIFICATIONS

ELECTRICALS

System	12V - DC
Generation	Alternator
Alternator Output	156 W @ 1100 rpm
Battery	12V - 12 Ah VRLA
Head lamp	12V, H4 60/55 W
Brake/Tail lamp	12V, P21/5W (Halogen)
Turn signal	12V, R10W
Instrument Cluster	Digital Instrument Cluster with LCD
Horn	320 Hz Low and 420 Hz High Tone
Starter Motor	12V, 0.8 KW



WARNING

Using bulbs / other electrical accessories other than specified rating may lead to over loading / erratic behaviour / premature failure of electrical system. Modifications on the motorcycle which are not approved by Royal Enfield may not only disqualify for warranty, but will also affects the performance of the motorcycle.

TECHNICAL SPECIFICATIONS

DIMENSIONS

Rake	24 degrees
Front Wheel	18 M/C x MT 2.50
Rear Wheel	18 M/C x MT 3.50
Length.....	2119 mm
Width	833 mm (with mirrors)
Height	1067 mm
Wheel base	1398 mm
Ground Clearance	174 mm

TECHNICAL SPECIFICATIONS

WEIGHTS

Kerb weight (90% Fuel and Oil)	208 kg
Max. payload	200 kg (Inclusive of rider mass)

NOTE

- Values / dimensions given above only for your guidance.
- In view of continuous improvements being done on our products, the specifications could change without prior notice.

RECOMMENDED LUBRICANTS

Engine Oil			Front Fork Oil		Brake Fluid	
Grade	Fully synthetic 10W-50 to API SL (or higher) or JASO MA2, such as ELF MOTO4 TECH 10W 50		Grade	2W 25 HPCL	Grade	DOT 4
Capacity	1st Dry Fill : 4.12 quart / 3.9 Litre	Routine Oil Change : 3.27 quart / 3.1 Litre	Capacity	0.50 quart / Fork	Capacity	Front: 0.05 quart Rear: 0.10 quart
			* DO NOT Mix DOT 4 or other brake fluids together.		Brake System	
					Dual Channel ABS	

CAUTION

Use of wrong oil grade will reduce the life of the moving parts and seriously affect performance.

NOTE

Recommendation subject to change without notice.

ISO 14001 OPERATION CONTROL PROCESS

As per the guidelines in ISO 14001 Environmental Management System, customers are advised to carry out timely replacement of engine oil, fork oil and brake fluid, ONLY through a Royal Enfield Authorized Service Centre for the safe disposal of the used oils to prevent environmental pollution.

In case the oils are replaced privately, it is advised to ensure the old / removed oils are collected carefully and disposed through a certified disposal agency.

Similarly, hazardous waste such as old / discarded batteries, Tires, tubes, cables, gaskets, oil filters etc. should also be disposed off carefully and properly, through a certified disposal agency.

MOTORCYCLE IDENTIFICATION NUMBERS

CHASSIS NUMBER

Punched on the steering head tube right side



COMPLIANCE LABEL

Pasted on RH Headstock Gusset

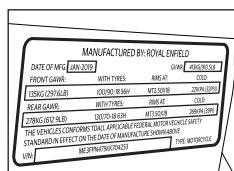

EMISSION LABEL 1

Pasted on under seat frame tube rear face of the upper cross beam tube

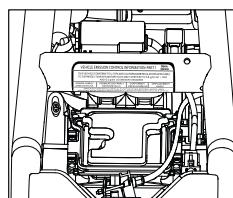

EMISSION LABEL 2

Pasted on LH side of the headstock tube

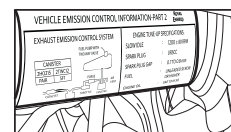

NOISE LABEL

Pasted on LH Headstock Gusset



CAUTION

It is illegal to tamper with the VIN information label as it is the only means of identifications of the motorcycle.

ENGINE NUMBER - DETAILS

The engine number is punched above the oil filter location. It is the means of identification of the engine serial number and its production details. It is illegal to tamper with the engine number as it is the only means of identifications of the engine.

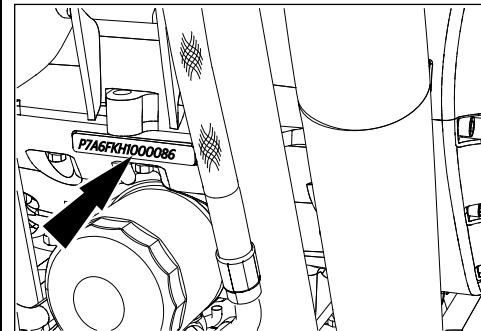
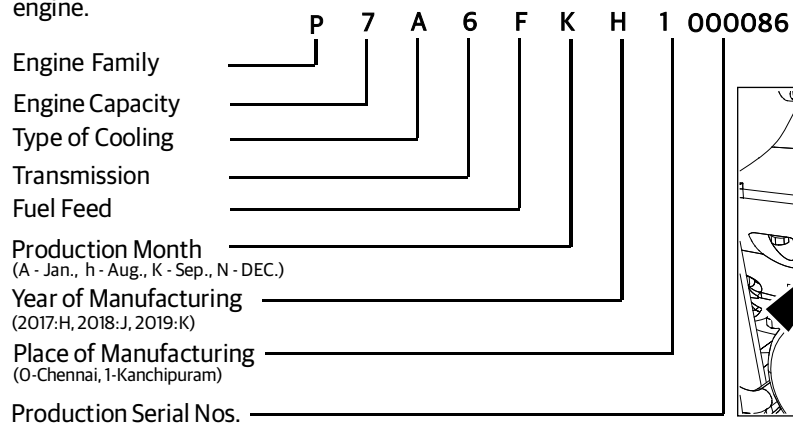

LOCATION OF KEY PARTS

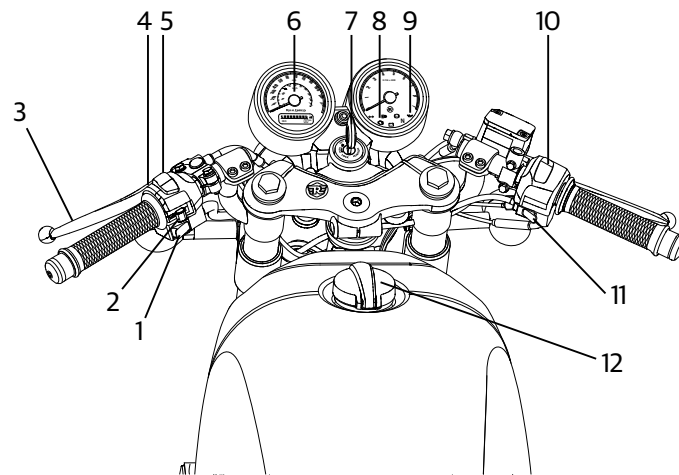

1. Horn Button
2. Turn Signal Switch
3. Clutch Lever
4. Day Flash Switch
5. High Beam / Low Beam Switch
6. Instrument Cluster
7. Ignition Switch
8. Malfunction Indicator Lamp
9. RPM (Tacho) Meter
10. Engine Kill switch
11. Electric Start Switch
12. Fuel Tank Cap

LOCATION OF KEY PARTS

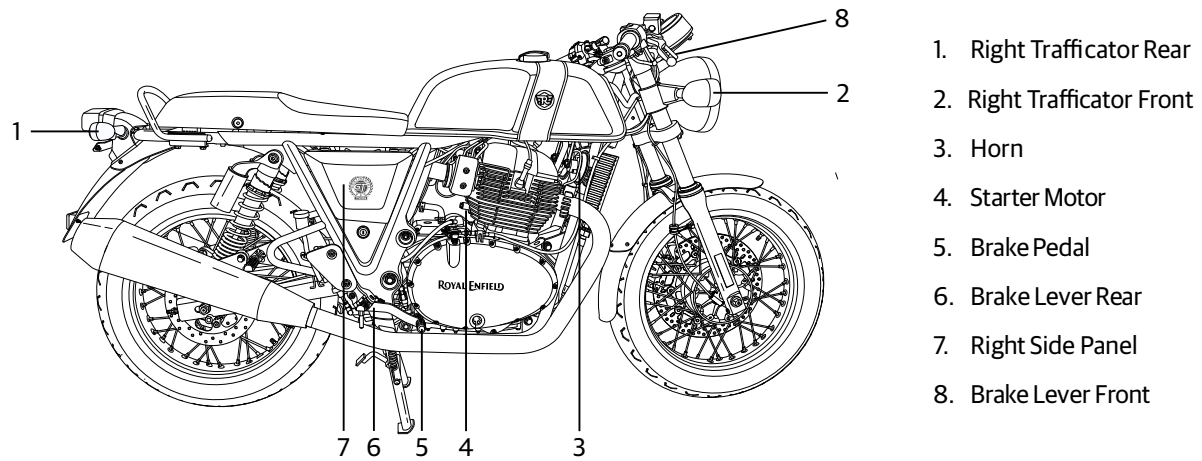

LOCATION OF KEY PARTS

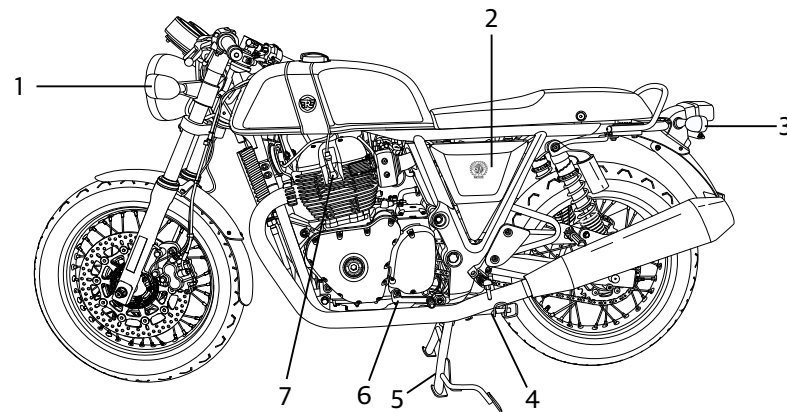

1. Left Trafficator Front
2. Left Side Panel / Battery Cover
3. Left Trafficator Rear
4. Side Stand
5. Centre stand
6. Gear Change Pedal
7. Spark plug

NOTE

The centre stand is not OE fitment in Continental GT 650 model.

OPERATION OF CONTROLS

IGNITION SWITCH

⊗ OFF: Steering unlock, ignition "OFF"

○ ON: Steering unlock, ignition "ON"

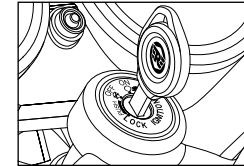

NOTE

- Key is common for ignition, petrol tank lock, steering lock and side panels.
- Key can be removed from fuel tank, side panel only in locked position from the key slots.

STEERING LOCK

- Turn the handle bar to extreme left or right position.
- Push the key inside at "OFF" position, press and further turn to anticlockwise direction to lock the steering and remove the key.
- To unlock, insert the key in steering at lock position, and turn clockwise direction.



OPERATION OF CONTROLS

FUEL TANK CAP

- Lift key flap on fuel tank cap and insert key.
- Turn key clockwise to open.
- Press cap to lock with key in position.
- Remove key from cap and close flap

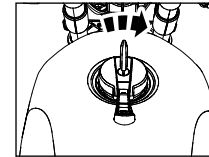

WARNING

- DO NOT overfill the fuel tank.
- Fill fuel only till the bottom of anti splash plate.
- Over filling may result in gasoline entering the EVAP canister and may damage the Evaporative Emission System.

CAUTION

Gasoline vapour is highly explosive. Please ensure there are no open flames or sparks nearby while refueling and fill fuel only in a well ventilated area.

Please ensure gasoline does not spill on painted surfaces. In case fuel spills over the painted surfaces wipe it off immediately as it may leave a permanent stain.

Do not smoke while refueling or when fuel tank cap is open.



OPERATION OF CONTROLS

FUEL FILLING LEVEL

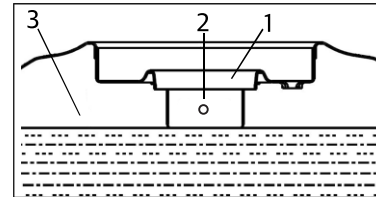
1. Fuel filler collar
2. Anti splash plate
3. Maximum fuel level



ENGINE KILL SWITCH

-  Engine "OFF"  Engine "ON"

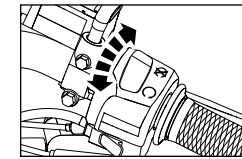

CAUTION

- Turn off ignition switch when engine is not running. Failure to do so will discharge the battery due to the headlamp being continuously "ON".

OPERATION OF CONTROLS

E-START SWITCH

 Depress and hold until engine starts for a maximum of 5 seconds.

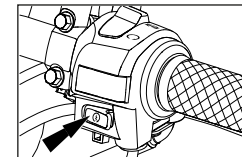

HORN

 Press the horn button to sound horn.

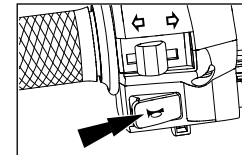

HI BEAM / LOW BEAM SWITCH

■ When the headlamp is in ON condition "High / Low beam" will be selected by toggling the switch. High beam indicator lamp located in instrument cluster will glow when high beam is selected.

 High beam  Low beam

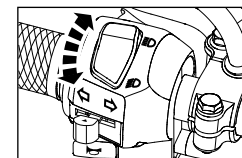

OPERATION OF CONTROLS

DAY FLASH

Press the switch for Day flash.

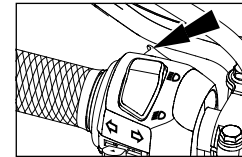

TURN SIGNAL SWITCH

- ← Left turn signal "ON"
- Right turn signal "ON"
- ↑ "OFF" (Push to cancel)

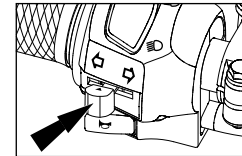

Push the button from "OFF" position to either left or right before turning as needed and restore to "OFF" position to stop blinking.

OPERATION OF CONTROLS

SIDE PANEL LEFT

- To access the left side panel remove the seat and retaining screw, pull and disengage the side panel from locator and gently remove the side panel.

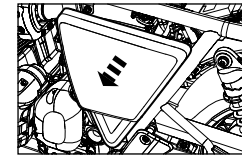

SIDE PANEL RIGHT

- Turn key clockwise to unlock the side panel.
- Pull the side panel along with key to gently remove the side panel.

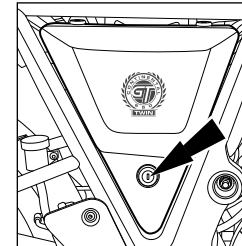

OPERATION OF CONTROLS

INSTRUMENT CLUSTER

This instrument cluster consists of the following:

1. Speedometer
2. Odometer
3. Selection Button
4. Trip Meter 'A' and 'B'
5. Turn Signal Indicator
6. Hi beam Indicator
7. Engine Malfunction Indicator
8. Battery Low Voltage Indicator
9. Fuel Level Indicator
10. ABS Indicator

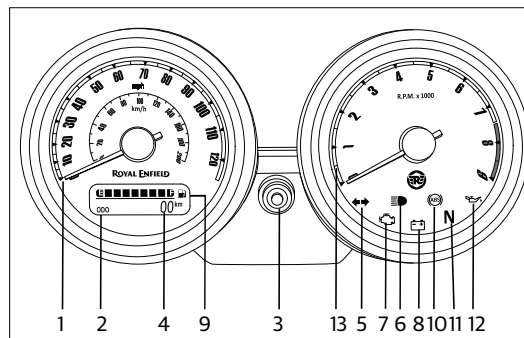

11. Neutral Indicator
12. Low Oil Pressure Indicator
13. Tachometer

OPERATION OF CONTROLS

1. SPEEDOMETER

The Speedometer indicates the speed at which motorcycle is travelling and has both kms/miles calibration.

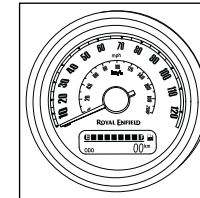

2. ODOMETER

The default display in the odometer is the total kms/miles, the motorcycle has covered



NOTE

The last selection mode will be displayed whenever ignition is switched "ON".



WARNING

It is illegal to tamper with the odometer display or reset the total kms/miles, the motorcycle has covered.
It is illegal to ride the motorcycle after disconnecting the speed sensor of the motorcycle.

OPERATION OF CONTROLS

3. SELECTOR BUTTON

The selector knob will help to select between odometer, Trip 'A' or Trip 'B'.

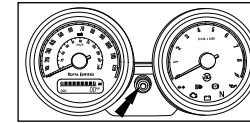

4. TRIP METER A AND B

A light push for less than one second on the select button switch will change the display from odometer Trip 'A'. Again another press on the select button switch will change the display from Trip 'A' to Trip 'B'.

NOTE

1. Set the display as Trip 'A' or Trip 'B' as current mode.
2. Press the select button for more than 3 seconds.
3. Automatically the display will become zero.



WARNING

Do not attempt to change any setting while riding the motorcycle. It may cause loss of control leading to an accident.

OPERATION OF CONTROLS

5. TURN SIGNAL INDICATOR

Indicates that either the left or right indicators are "ON".

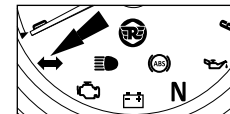

6. HI BEAM INDICATOR

Indicates that the high beam head lamp is "ON".



7. ENGINE MALFUNCTION INDICATOR LAMP

A Malfunctioning indicator lamp (MIL) is provided in the tachometer.

When both the ignition and engine kill switch is in "ON" position and after vehicle is started, the MIL will glow for few seconds and switch "OFF" this indicates that all the functions of Electronic fuel injection (EFI) system is functioning normally. In the event of any malfunction in the EFI system MIL will glow continuously. It is recommended to take the motorcycle to a nearest Royal Enfield Authorized Service Centre for a detailed inspection and correction of EFI system.

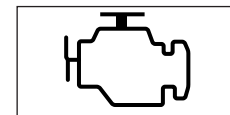

OPERATION OF CONTROLS

8. BATTERY LOW VOLTAGE INDICATOR

When the ignition switch is turned in "ON" position, low voltage indicator symbol will glow. As soon as the engine is started the battery low voltage indicator turns "OFF" automatically.

In case the battery voltage is below 12 volt and the battery is not charging when the engine is started, the battery low voltage indicator will continue to glow in the instrument cluster.

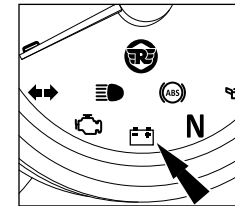

CAUTION

DO NOT ride the motorcycle if the battery low voltage indicator is glowing continuously and please get the charging system checked through an Royal Enfield Authorized Service Centre immediately.

WARNING INDICATIONS AND SAFETY SYSTEMS

Your motorcycle is fitted with the following warning indications and safety systems:

9. FUEL LEVEL INDICATOR

The fuel level indicator indicates the level of fuel in the fuel tank.

The display bars of the fuel meter fades towards the empty (E) when the fuel level decreases from full tank level (F).

The last bar of the fuel level indication in the instrument cluster will blink continuously when the fuel is less than 3.17 quart.

Please do not ride the motorcycle with the low fuel indication blinking continuously as it may not only result in the motorcycle running out of fuel, but will also cause serious damage to the fuel pump. Please refuel as soon as the low fuel indication starts blinking.

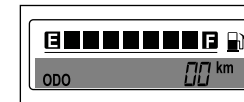

WARNING INDICATIONS AND SAFETY SYSTEMS

10. ANTI-LOCK BRAKING SYSTEM (ABS)

Anti-Lock Braking System (ABS) will help prevent the brakes from locking the wheels, during sudden application of the brakes at high speeds or at low friction surfaces. This will help the rider to have better traction and control over the motorcycle and prevent the motorcycle from skidding which can cause an accident.

In the event of a sudden and hard application of the brakes by the rider, the sensors in the braking system will signal the ABS modulator to momentarily and continuously reduce the hydraulic pressure and thereby prevent the brakes from locking the wheels while reducing the speed of the vehicle. This will help the rider to control the motorcycle.

An ABS indicator lamp is provided in the cluster (as shown in the adjacent image) to warn the rider in the event of any malfunction of the ABS.

When the ignition and engine kill switch are switched in "ON" position the ABS sign will glow and remain "ON" till the motorcycle attains a speed of 5 kmph / 3 Mph and turns "OFF". This indicates the ABS is functioning properly. If the ABS indicator lamp does not switch "OFF" and remains continuously "ON" at higher speeds, it is recommended not to drive the ABS motorcycle. Get the brake system inspected and corrected through a nearest Authorized Royal Enfield Service Centre. Failure to do so can result in a serious injuries and loss of life.

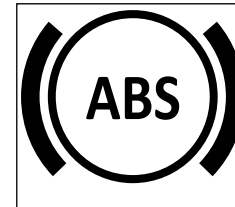

WARNING INDICATIONS AND SAFETY SYSTEMS

CAUTION (ABS)

ABS is a safety feature to help prevent locking of wheels during panic application of brakes. It is by no means a substitute for good riding practices and anticipatory braking.

Please ride carefully and apply brakes cautiously, especially while cornering. ABS cannot estimate the "weight shifts" and momentum of the motorcycle while negotiating a corner and therefore prevent skidding due to loss of traction.

Please anticipate the stopping distance required for the speed of travel and apply brakes well in advance so as to bring the motorcycle to a safe stop.

Please apply both brakes simultaneously to stop with better traction and control of the motorcycle.

Failure to adhere to the above can cause an accident resulting in serious injuries and loss of life.

WARNING INDICATIONS AND SAFETY SYSTEMS

DO'S AND DON'T'S : (ABS)

DO'S	DON'TS
<ul style="list-style-type: none">■ While starting the engine do check the ABS indicator glows "ON" and turns OFF when the vehicle speed exceeds 5 km/h (3.1mph).■ Please check the brake fluid at "MAX" level in the front and rear brake reservoir and ensure there is no leak in the brake systems.■ Apply both the brakes simultaneously for better efficiency.■ In the event of the ABS indicator remaining continuously "ON", please take the motorcycle to a nearest Authorized Royal Enfield Service Centre to inspect the brake system.	<ul style="list-style-type: none">■ DO NOT RELEASE the brake lever/pedal when pulsations are felt during hard application of the brakes in an emergency situation. The pulsations only indicate that the ABS is activated.■ DO NOT APPLY only the front OR rear brake as it can lead to inefficient braking.

11. NEUTRAL INDICATOR

This indicator glows when the vehicle is in neutral position.

12. LOW OIL PRESSURE INDICATOR

This indicator glows whenever the oil pressure is too low. When the ignition switch is in "ON" position with the engine not running condition the indicator goes off when the engine oil pressure is high enough / normal condition.

WARNING INDICATIONS AND SAFETY SYSTEMS

CAUTION

When the indicator glows continuously and if the engine speed is above idle, stop the vehicle immediately and get the engine inspected and corrected through a nearest Authorized Royal Enfield Service Centre. Failure to do so can cause engine damage.

13. TACHOMETER

This indicates the engine speed in RPM.

ROLL OVER SENSOR

In the event of motorcycle falling over on either of its sides with the engine running and the gear engaged the roll over sensor will disable both the ignition and fuel systems and switch "OFF" the engine. This is to prevent further damage to the motorcycle and the rider.

To reset the roll over sensor and reactivate the ignition and fuel systems.

- Ensure the motorcycle is parked upright on a firm surface.
- Ensure gear is in neutral position and the neutral lamp is glowing in the instrument cluster.
- Turn "OFF" ignition and switch "OFF" engine kill switch, wait for a few seconds and turn "ON" the Ignition and switch "ON" engine kill switch once again, to start the engine.

PRE OPERATIONAL CHECKS

A careful check on the following aspects must be carried out every time before riding and especially after long periods of storage to determine if any additional maintenance is necessary.

1. Adequate fuel in the tank for the journey planned.
2. Tires for correct pressure, abrasions or cuts.
3. Ensure chain for proper tension and sufficient lubrication.
4. Brakes, clutch, steering and throttle for proper responsiveness.
5. Handle bar controls for smooth operation.
6. Engine oil level.
7. Wheel spokes for proper tightness and damage.
8. Headlamp, tail lamp, brake lamp and indicator lamps for proper functioning.
9. Proper functioning of all the warning lamps in the instrument cluster.



WARNING

For your personal welfare and safety, all the points mentioned above should be performed periodically. Failure to do so may affect safe operation, damage your motorcycle and could result in an accident causing serious injury or loss of life.

RUNNING IN PERIOD

The Royal Enfield Motorcycle as you would be experiencing is capable of consistent high speeds. However as with any new motorcycle, a "RUNNING-IN" procedure is essential to help in proper "Bedding-In" of the various moving parts in your motorcycle and to achieve optimum performance subsequently.

1. DO NOT exceed maximum specified pay load.
2. Warm up the engine for a few minutes at idling speed to allow engine oil to lubricate all the moving parts in the engine before riding the motorcycle.
3. Avoid full throttle operation and do not ride at constant throttle continuously. Vary the speed by 10% while riding.
4. It is recommended to use half clutch condition when commuting in the city traffic condition alone (Engine RPM around idling to 2000 RPM) at 1st gear condition. In Other gears and higher RPM avoid using half clutch which will proportionately reduce the clutch life. During acceleration/ deceleration disengage the clutch completely, shift the gear and engage the clutch gradually (Not too slowly).
5. Ride at proper speed and avoid sudden accelerations and braking.
6. Avoid riding motorcycle continuously for over an hour, it is recommended to take brief stop.

RUNNING IN PERIOD

During the first 2000 Kms (1200 miles) of run, do not exceed the speed limits as shown in the table below.

Motorcycle Speed

Gear	First 300 miles	301 - 1200 miles
1	10 mph	10 mph
2	15 mph	20 mph
3	20 mph	25 mph
4	30 mph	35 mph
5	40 mph	45 mph
6	50 mph	55 mph

NOTE

The below table indicates the recommended engine speed in rpm for optimum performance of the engine.

Distance Covered	Max. Engine Speed
0 to 800 kms (0 to 500 miles)	4000 rpm
800 to 1600 kms (500 to 1000 miles)	6000 rpm

STARTING

- To shift into neutral, move the motorcycle back and forth gently, while simultaneously shifting the gear. Ensure gear is in neutral position and the neutral lamp is glowing in the instrument cluster.

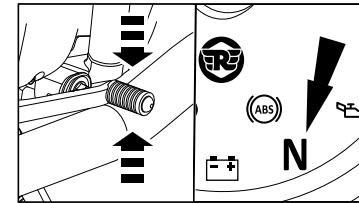

- Turn ignition key to "ON" position and engine kill switch on right hand side handle bar to "RUN" position.

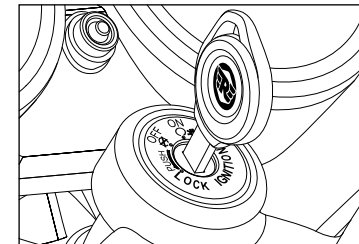

STARTING

- When both the ignition and engine kill switch is in "ON"  position and after the vehicle is started, the MIL will glow for a few seconds and turns "OFF", this indicates that all the function of the electronic fuel injection (EFI) system is functioning normally. In the event of any malfunction in the EFI system the MIL will glow continuously.

CAUTION

- In case the malfunction indicator DOES NOT turn "OFF", get the motorcycle checked through an Royal Enfield Authorized Service Centre for rectification.
- Check the fuel level indicator in the cluster for adequate fuel in the fuel tank. In case the last bar is blinking continuously, it indicates low fuel level in the tank. Please re-fuel immediately.

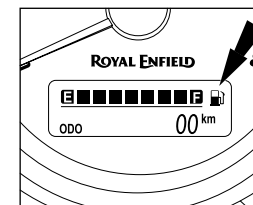
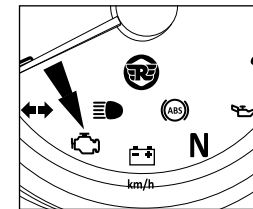

STARTING

- Disengage clutch by pulling in the clutch lever and hold it in depressed condition.
- Depress and hold electric start switch until engine starts for a maximum of 5 seconds.

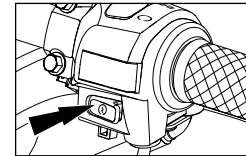
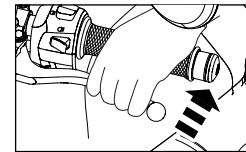

NOTE

In case the engine does not start within 5 second, release starter switch and wait for about 5 second before attempting to start the engine again.

STARTING

CAUTION

If the engine does not start. DO NOT hold the starter switch in depressed condition for long periods, this will cause the battery to drain below the threshold level of 10 volt. Please get the motorcycle checked through an Royal Enfield Authorized Service Centre to identify and correct the reason for not starting.

CAUTION

NEVER accelerate as soon as the engine starts, especially in cold condition. The engine should be allowed to run in idle RPM for at least 2 minute for the engine oil to circulate and lubricate all the internal moving parts and for the engine temperature to raise. Failure to adhere to this important information will cause serious damage to the engine internals.

Accelerate only after the idling RPM has stabilised and it is consistent.

- Ensure side stand is in fully retracted position. Failure to do so will cause the engine to switch "OFF" as soon as gear is engaged.



WARNING

Please exercise extreme care while riding the motorcycle. Failure to do so can result in an accident causing injury to you or to other road users / passerby.

GEAR SHIFTING, RIDING AND STOPPING

The clutch lever must be fully depressed before attempting a gear shift. Failure to fully depress the clutch lever will cause a roughstart OR stalling of the engine besides causing damage to transmission parts.

- When the vehicle is in Neutral position, press gear shift lever down with toe to engage 1st gear.

GEAR SHIFT PATTERN

1-- N -- 2 -- 3 -- 4 -- 5 -- 6

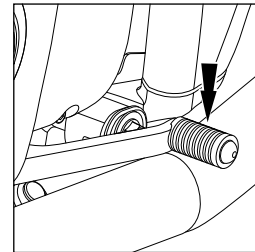

GEAR SHIFTING, RIDING AND STOPPING

CAUTION

- If the clutch lever is released abruptly and throttle opening is done insufficiently the motorcycle will have a rough start and cause the engine to stall.
- If the acceleration is very high and clutch lever is released abruptly, it will cause motorcycle to move suddenly, which will lead to loss of control leading to an accident resulting in injury and or loss of life to rider / other road users / passed by, besides damage to the motorcycle.
- Always exercise utmost caution while releasing clutch and riding the motorcycle.
- Lift gear shift lever up with toe to shift to 2nd and subsequent gears.
- As soon as the motorcycle reaches a speed of 20 kmph in 1st gear position, shift to 2nd gear and to higher gears as the speed of the motorcycle increases.

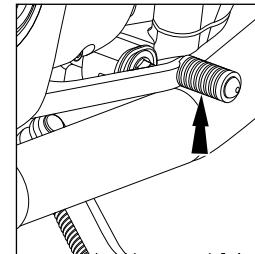

GEAR SHIFTING, RIDING AND STOPPING

NOTE

Always start motorcycle with the gear in neutral position.

When the engine speed decreases or while climbing a gradient or running at a reduced speed, shift to the appropriate lower gear to prevent the engine from stalling or straining to pull.

- Always shift to lower gears as appropriate whenever slowing down to stop the vehicle.
- Shift gears to neutral position just before bringing the vehicle to a complete stop always.
- Close throttle fully and release the clutch lever slowly ensuring the motorcycle is in neutral position and neutral lamp is glowing.
- Stop the the motorcycle in a safe place, turn "OFF" ignition and switch "OFF" engine kill switch.

GEAR SHIFTING, RIDING AND STOPPING

Gear Shift Speeds			
Up Shift	Speed (km/hr)	Speed (mph)	Engine RPM
1st to 2nd gear	25.7	16	3000
2nd to 3rd gear	40.2	25	3250
3rd to 4th gear	54.7	34	3500
4th to 5th gear	69.2	43	3750
5th to 6th gear	83.7	52	3950
Down Shift			
Down Shift	Speed (km/hr)	Speed (mph)	Engine RPM
6th to 5th gear	80.5	50	3500
5th to 4 th gear	64.4	40	3000
4th to 3rd gear	48.3	30	2550
3rd to 2nd gear	32.2	20	2050

PARKING

PARKING MOTORCYCLE ON CENTRE STAND

- Select a firm, flat surface.
- Hold handle bar firmly in a straight position.
- Lower centre stand, such that, both the legs of the stand are resting on a firm ground.
- Apply pressure on the fulcrum lever on the centre stand and pull the motorcycle backward.
- Lock the steering and ensure the handle bar is locked firmly before removing the key from the ignition barrel.

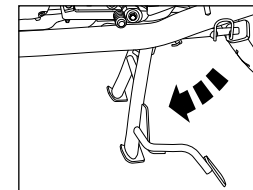

NOTE

The Centre stand is not an of fitment on the Continental GT 650 models. The centre stand can however be fitted as an accessory at extra cost. Please contact nearest Royal Enfield Authorised Service Centre, in case you wish to assemble a centre stand as an accessory.

PARKING

PARKING MOTORCYCLE ON SIDE STAND

- Select a firm, flat surface.
- Extend side stand. Tilt the motorcycle to the left side, till it is supported firmly on the ground.

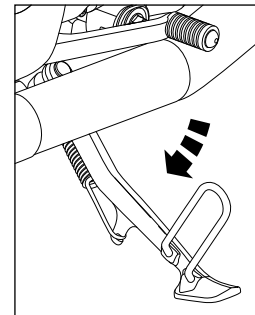

⚠ WARNING

Ensure both stands are fully retracted before riding the motorcycle.

Please exercise extreme care while parking and ensure it is parked on a firm and flat surface to avoid the motorcycle from falling over and causing injury to you or to others and damage to the motorcycle parts.

TOOLS KIT

The tool kit is located in the right side panel of the motorcycle.

S.No.	Description	Qty.
1.	C Spanner	1
2.	Allen Key 6mm	1
3.	Allen Key 5mm	1
4.	Allen Key 4mm	1
5.	Extension Tube	1
6.	Ring Spanner 24 x 14 Combination	1
7.	Screwdriver 06 x 160	1
8.	Double End Spanner 10 x 12	2

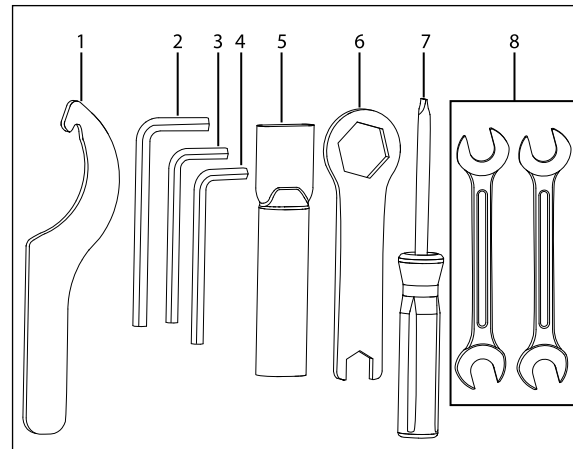

MINOR MAINTENANCE TIPS

The following simple maintenance activities will help maintaining your motorcycle. However, for an complete maintenance, we recommend you to get in touch with a Royal Enfield Authorized Service Centre.

HAND LEVERS, CENTRE AND SIDE STAND PIVOTS

- Clean the pivot points and ensure they are free of any dirt, grime, rust, etc.
- Lubricate the pivots.

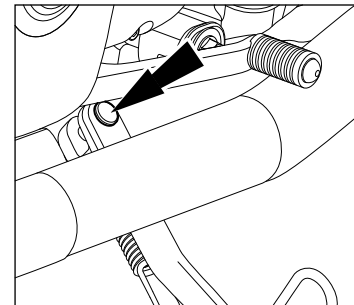

NOTE

Wipe off the excess lubricant to prevent dirt and grime from accumulating.

MINOR MAINTENANCE TIPS

DRIVE CHAIN

- Spray drive chain with recommended chain cleaning solvent while simultaneously rotating rear wheel.
- Ensure the drive chain has been sufficiently and completely covered with the cleaning solvent. If necessary use a suitable brush to remove hard deposits from the chain.
- Wait for a few minutes and clean the chain thoroughly from any dirt, grime, etc.
- Rotate rear wheel slowly and simultaneously apply recommended chain lubricant on the chain links.
- Wipe off excess chain lubricant after a few minutes with a clean cloth.

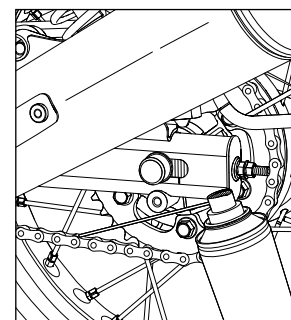
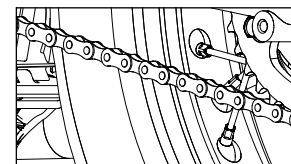

MINOR MAINTENANCE TIPS

OIL LEVEL INSPECTION

- Ensure motorcycle is in upright position on a firm and flat surface on its centre stand.
- Start the engine and allow it to run in idling rpm for about 2 minute and switch off the ignition.
- Wait for 2 minute for the oil to settle down and check oil level through the window on RH cover of the engine.
- The level is correct only if the oil is found between the "MIN" and "MAX" marks on the cover RH.
- If necessary top up ONLY with recommended engine oil till the level is between the "MIN" and "MAX" markings.

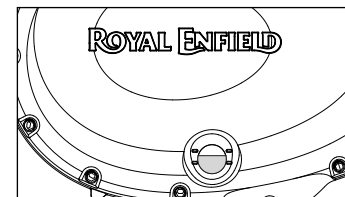

CAUTION

Use of wrong grade or spurious oils can seriously affect motorcycle performance and damage to moving parts. DO NOT over fill beyond the "MAX" level or allow oil level to drop below the "MIN" level.

MINOR MAINTENANCE TIPS

- Remove the engine oil filler cap for adding the engine oil.

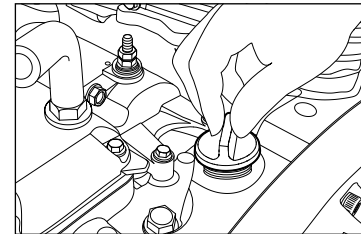

- Place a clean tray under the engine oil magnetic drain plug. Remove it along with the washer to drain oil completely from the engine.

 **WARNING**

DO NOT spill the engine oil. Store used oil in a separate container and dispose it. Avoid skin or body contact with the oil. Promptly wash the affected areas with soap and water till it is cleaned thoroughly.

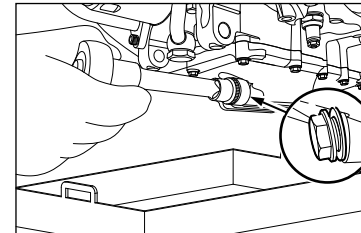

MINOR MAINTENANCE TIPS

NOTE

Ensure the engine oil is drained completely. Drain the oil completely and to avoid oil spilling.

ENGINE OIL FILLING

- Place a container under engine oil drain bolt.
- Gently apply thread sealant on drain plug thread.
- Insert the drain plug bolt along with new washer.
- Tighten the drain plug bolt to 35 Nm.
- Refill the engine oil recommended level.
- Close engine oil filler cap.
- Start and warm up engine for 2 to 3 minutes and then turn it off. Check oil level through oil level window.

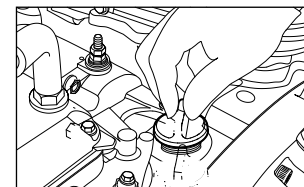
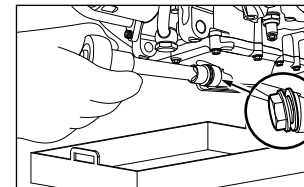

CAUTION

DO NOT over fill engine oil as excess oil will spill over through the crankcase breathing system and clog the air filter.

MINOR MAINTENANCE TIPS

SPARK PLUG

CLEANING SPARK PLUG AND ADJUSTING GAP

- Disconnect spark plug caps from the spark plugs.
- Locate spark plug spanner on the spark plug, loosen spark plug and remove it from cylinder head.
- Check spark plug for carbon deposits and centre electrodes for uneven wear.
- Clean spark plug by positioning it in a spark plug cleaning machine.
- Remove spark plug from the cleaning machine, check and set electrode gap between 0.7 to 0.8 mm.
- Position spark plug in the spark plug testing machine and check for proper functioning of the spark plug.
- Always replace spark plugs ONLY as per recommended specification.
- Apply a thin film of "anti seize" on the spark plug mounting and threads fix the spark plug by hand tightening.
- Tighten spark plug to torque 10 to 15 Nm by using a spark plug spanner.

Gap 0.7 to 0.8 mm.



MINOR MAINTENANCE TIPS

BRAKE FLUID FRONT AND REAR

- Ensure motorcycle is upright on a firm flat surface on its centre stand.
- Check brake fluid level in the window on front and rear reservoirs.
- The level is correct if the oil level is between the "MIN" and "MAX" marks.
- Open the reservoir cover and remove diaphragm carefully to top up the brake fluid.
- Top up only with DOT 4 brake fluid until level is between "MIN" and "MAX" marks in the reservoir.
- Replace diaphragm correctly and close cover firmly.
- Wipe off any excess / spilled brake fluid immediately with a clean cloth.

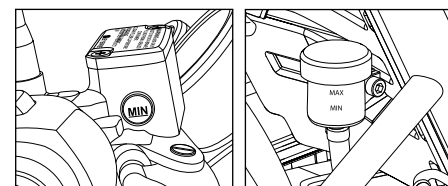

Front Brake

Rear Brake

CAUTION

Brake fluid is highly corrosive and can cause damage to painted parts. Please ensure that brake fluid does not spill on any part of the motorcycle. In the event of a spill, please clean the area immediately with a soft wet cloth to avoid damage to the affected part.

DO NOT mix different brake fluid grades. Use ONLY DOT 4 Brake fluid.

MINOR MAINTENANCE TIPS

INSPECTION OF Tires AND WHEELS

- Inspect the Tires periodically for tread wear, cracks and cuts.

Minimum tread depth :	
Front Tire : 1 mm	Rear Tire : 2 mm

- Check and remove stone, splinters, nails or other particles embedded in the Tire treads.
- Periodically inspect wheels for spokes damage and wheel rim for wobbling or run out.
- Check uniform seating of the Tire beading on the rim whenever the Tire is reassembled.
- Use only recommended Tires and tubes, inflated to correct air pressure as given below.

	Front	Rear
Solo	32 psi/2.20 kg/cm ²	36 psi/2.53 kg/cm ²
With Pillion	32 psi/2.20 kg/cm ²	39 psi/2.74 kg/cm ²

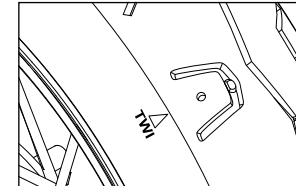

MINOR MAINTENANCE TIPS

FRONT WHEEL REMOVAL

- Ensure motorcycle is upright on a firm and flat surface.
- Place a wooden block on the front end of engine to support the motorcycle and ensure front wheel is off the ground by minimum 2 inches.
- From wiring harness RH side disconnect the speedo drive coupler.
- Loosen the pinch bolt on the front fork bottom right side.
- Remove the axle nut along with washer, hold the wheel axle on the right side and loosen hex nut on the left completely.
- Remove axle nut and washer from wheel axle.

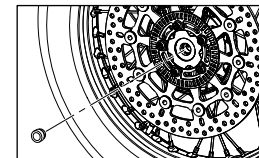
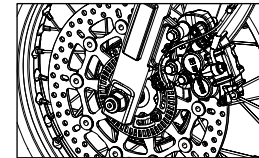
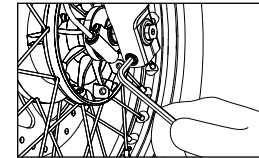

MINOR MAINTENANCE TIPS

- Tap and remove the front wheel spindle, gently tap axle from left side while supporting wheel at the bottom then remove axle from the right side.

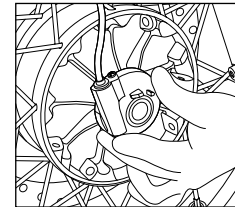

CAUTION

Take care to secure the wheel spacers and speed sensor while removing the axle from the forks.

- Slide out the front wheel from the forks.

CAUTION

Do not press the brake lever when front wheel is removed as this will result in the brake pads coming too far out of the brake caliper.

- Place a 4 mm thick wooden piece or cardboard sheet between the brake pads to avoid pads activation in the event the front brake lever is accidentally pressed.
- Take care not to damage the front brake disc or tonering as it will affect the braking system and ABS.

MINOR MAINTENANCE TIPS

FRONT WHEEL REASSEMBLY

- Remove the wooden piece / cardboard sheet placed between the brake pads
- Locate speedo drive to its correct position on the right side.
- Locate stepped spacer to the wheel hub on left side.
- Insert the wheel along with speedo drive and spacer between the fork ends. Ensure the brake disc is located between the brake pads.
- Support front wheel at the bottom and ensure the mounting holes are aligned to insert the wheel axle along the right side fork end. Gently tap axle into wheel till the threaded portion of axle is fully visible on the left side fork end.
- Assemble washer and nut on axle.
- Hold the wheel axle firmly on right side and tighten axle nut firmly on left side to a torque of 70 Nm.
- Tighten pinch bolt completely on fork end to a torque of 25 Nm.

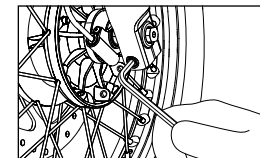
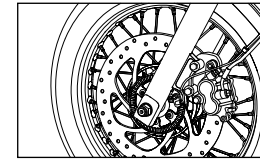
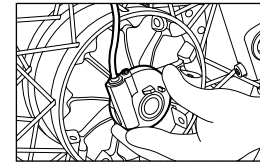

MINOR MAINTENANCE TIPS

- Rotate wheel to check for smooth rotation.
- Connect the speedo wire coupler and check for proper working of speedometer.
- Press brake lever and check front brake efficiency.

CAUTION

Please exercise utmost caution while reassembling the front wheel on the motorcycle.

Please ensure the wheel is fitted correctly before attempting to ride the motorcycle.

Failure to do so may result in the motorcycle not performing correctly, may lead to an accident causing injury to you / other road users and may lead to loss of life.

MINOR MAINTENANCE TIPS

REAR WHEEL REMOVAL

- Ensure motorcycle is upright on a firm and flat surface with the rear wheel at least 6 inches raised above from the surface.
- Observe and mark the alignment indexes on both chain adjuster on left and right side swing arm.
- Loosen the lock nuts and adjuster nuts fully on the left and right side chain adjuster.

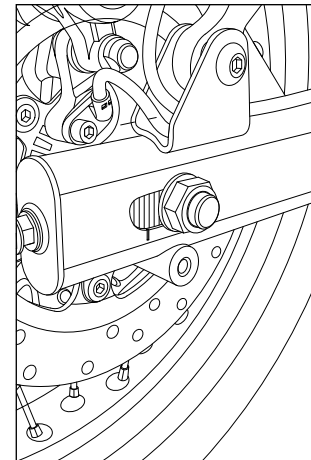

MINOR MAINTENANCE TIPS

- Hold wheel spindle on left side firmly and loosen hex nut on right side.
- Remove the nut and washer from the wheel spindle.
- Push rear wheel fully into the swing arm.
- Support rear wheel from bottom and pull out wheel spindle from the left side swing arm.
- Release the brake hose gently and remove caliper assembly from swing arm on right side.

CAUTION

- Ensure brake hose does not get damaged or kinked while removing.
- Support caliper assembly suitably and away from swing arm.
- Release the chain from the sprocket and ensure it does not get jammed or damaged when removing rear wheel.
- Remove support from wheel bottom and gently slide out rear wheel from the swing arm with rear sprocket, brake disc and spacers.

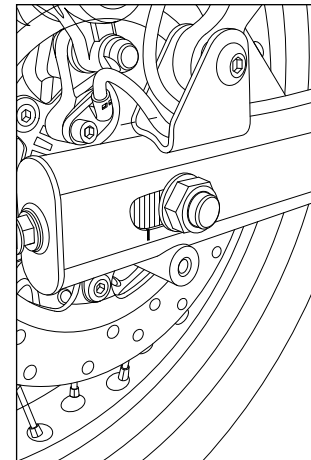

MINOR MAINTENANCE TIPS

CAUTION

Do not press the rear brake pedal when the rear wheel is being removed as this will cause the brake pads to dislocate from the brake caliper.

- Place a 4 mm thick wooden piece or cardboard sheet between the brake pads to avoid activation of brake pads if rear brake pedal is accidentally pressed.

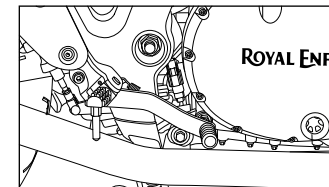

CAUTION

DO NOT pull up the rear brake pedal to lift or raise the motorcycle for any reason.

MINOR MAINTENANCE TIPS

REAR WHEEL REASSEMBLY

- Ensure that the long stepped spacer is located on the brake disc side and the short spacer is located on the sprocket side of the wheel hub firmly.
- Ensure that the chain adjuster are located properly inside the swing arm left and right sides.
- Locate caliper assembly on the tab along the swing arm right side.
- Locate rear wheel with the sprocket to the left side ensuring the brake disc in-between the brake pads on right side.
- Lift up the rear wheel and ensure that the slots in the swing arm brake caliper bracket holes in chain adjusters and the centre hole in the hub are aligned.
- Support rear wheel suitably and insert rear wheel spindle along the left side swing arm into the wheel hub.
- Ensure that the long stepped spacer is located along the brake side and the short spacer is located along the sprocket side on the wheel hub.

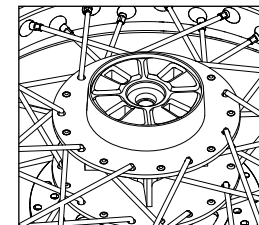
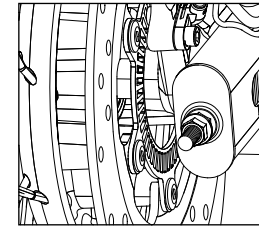

MINOR MAINTENANCE TIPS

- Tap spindle gently into wheel hub slot till the threads are completely visible on the right side.
- Assemble the drive chain on the sprocket and ensure it is seated correctly.
- Check for free and smooth rotation of the rear wheel.
- Assemble washer and hex nut on wheel spindle on right side.

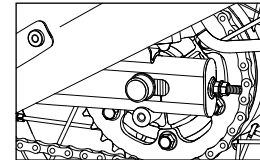
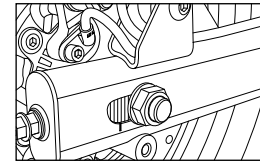

MINOR MAINTENANCE TIPS

DO NOT TIGHTEN HEX NUT FULLY

- Tighten chain adjuster nuts on left and right adjuster such that the index marks are aligned correctly on both sides of the swing arm.
- Check and ensure correct chain tension and wheel alignment.
- Hold spindle firmly on left side and tighten hex nut on right side set torque to 70 Nm.
- Locate the brake hose in the clips along the swing arm right side.
- Check rear brake for proper operating efficiency.

CAUTION

Please exercise utmost caution while reassembling the rear wheel on the motorcycle.

Please ensure the wheel is fitted correctly before attempting to ride the motorcycle.

Failure to do so will result in poor performance of motorcycle which may lead to an accident causing injury to you / other road users and may lead to loss of life.

MINOR MAINTENANCE TIPS

ADJUSTMENTS - CLUTCH

- Loosen the cable outer lock nut .
- Turn the nut clockwise to reduce the play or anticlockwise to increase the free play.
- Tighten lock nut after adjustment is done.
- Check free play 2 to 3 mm at clutch lever pivot on handle bar end, if desired free play is not achieved readjust.

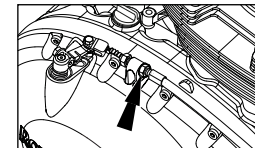
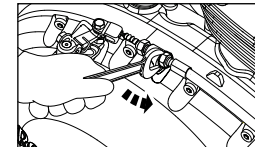

REAR BRAKE LIGHT

The brake light glows once you press the brake lever.

If brake light is not glowing, check the brake light switch wire for proper connection.

MINOR MAINTENANCE TIPS

DRIVE CHAIN TENSION (Free Play 20-30 mm)

- Park motorcycle up right on a firm and flat surface.
 - Ensure the motorcycle is in neutral position.
 - Measure the drive chain free play as shown. The drive chain free play is 20 mm to 30 mm.
1. If the drive chain free play is found to be incorrect adjust as follows:
 - a. Loosen the axle nut of the rear wheel axle.
 - b. Loosen the lock nut on the adjuster at both end of the swing arm.
 - c. To reduce the free play, tighten the adjuster nut on the adjuster evenly.

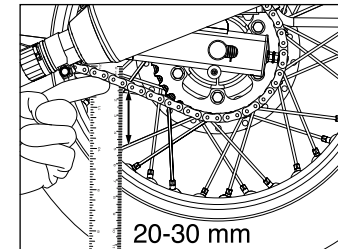

MINOR MAINTENANCE TIPS

- d. To increase the free play, loosen the adjuster nuts evenly and push the rear wheel forward.
- e. Check the chain for correct chain tension.
- f. Ensure that the index marks on the adjuster and swing arm are same on both left and right side of the swing arm.
- g. Hold spindle firmly to the left side and tighten rear hex nut to a torque of 70 Nm.
- h. Tighten the adjuster locknut using a 24mm spanner.



WARNING

Chain slackness beyond 30mm will lead to chain slippage and may also cause increased wear rates to chain and sprockets.

Maintain drive chain slackness within the specified limits at every 1000 kms interval.

Please ensure the both wheels are aligned correctly, after adjusting the chain and before tightening the rear wheel spindle nut.

MINOR MAINTENANCE TIPS

BATTERY AND MAINTENANCE

- The Motorcycle is provided with 12V - 12 Ah battery.
- The battery must be periodically checked for cleanliness and corrosion free terminals.

NOTE

The poor contact or loose fitment of battery terminals may cause ECU failure.

DISMANTLING

- Switch "OFF" the engine and remove ignition key from the key barrel.
- Disconnect battery negative (- ve) terminal bolt.

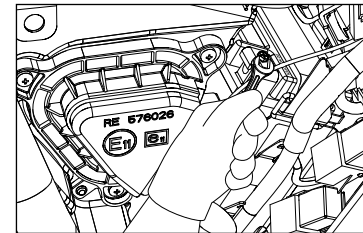
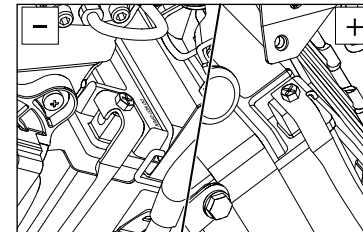

MINOR MAINTENANCE TIPS

- Remove 3 Nos. Hex head bolts from tool box to access the battery.

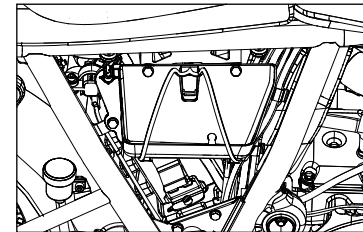

- Disconnect battery positive (+ve) terminal from battery.

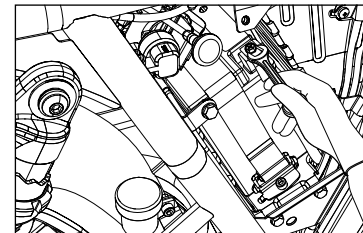

MINOR MAINTENANCE TIPS

- Pull battery strap (belt) downwards and release strap lock from battery strap bracket.

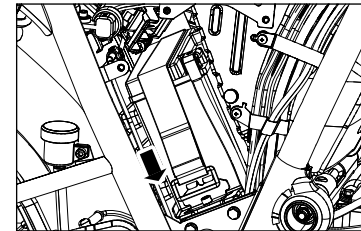

- Loosen and remove hex flange head screw from battery strap bracket.

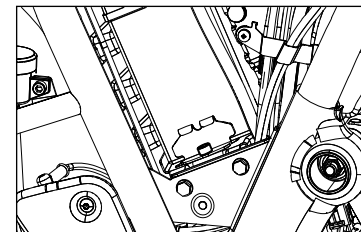

MINOR MAINTENANCE TIPS

- Remove battery strap bracket from battery tray.

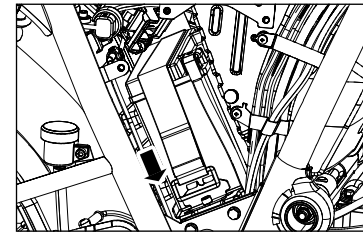

- Remove battery from tray.

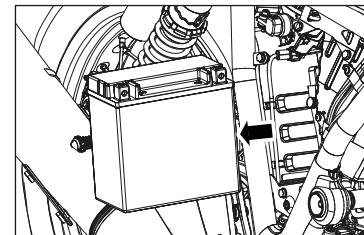

MINOR MAINTENANCE TIPS

WARNING

Always disconnect the black negative (-ve) battery cable first and then the red positive (+ve) cable while removing the battery connections.

NOTE

For checking the battery voltage contact Royal Enfield Authorized Service Centre or battery service centre.

MINOR MAINTENANCE TIPS

ASSEMBLY

- Assemble battery in to tray.

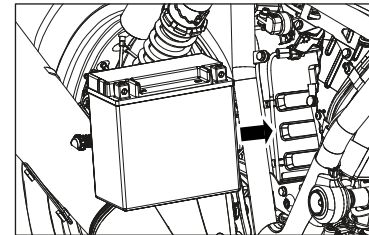

- Place battery strap bracket into battery tray.

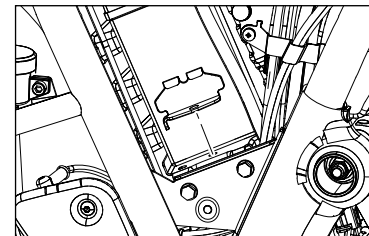

MINOR MAINTENANCE TIPS

- Locate and tighten flanged head screw into battery strap bracket.

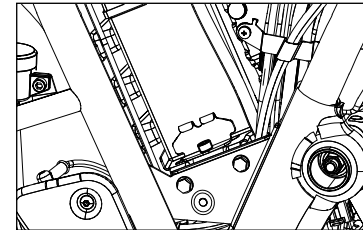

- Pull battery strap (belt) downwards to fix strap lock into battery strap bracket.

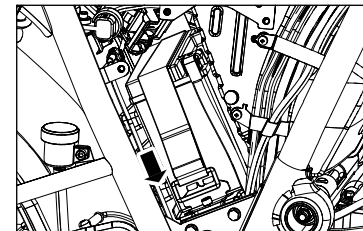

MINOR MAINTENANCE TIPS

- Connect battery red positive (+ve) terminal bolt.

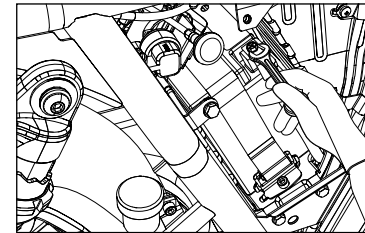

- Locate and tighten 3 nos. hex head bolts into tool holder.

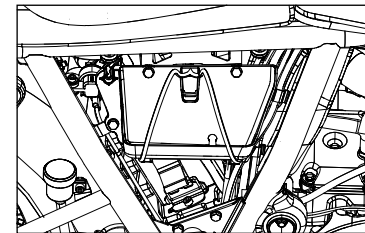

MINOR MAINTENANCE TIPS

- Connect red battery negative (-ve) terminal bolt.

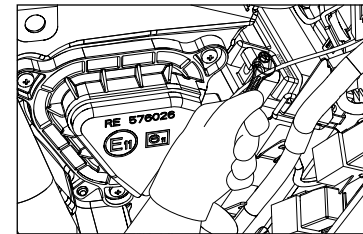

CAUTION

Connect the black (-ve) negative terminal after connect red (+ve) positive terminal only.

NOTE

Clean the wire terminals free from corrosion and keep the terminals coated with petroleum jelly.

CAUTION

Keep the red (+ve) positive terminal and (-ve) negative terminal cables firmly connected to the respective battery terminals. Failure to do so may result in damage to the motorcycle electrical system.

MINOR MAINTENANCE TIPS

CHANGING ELECTRICAL COMPONENTS

HEADLAMP BULB REPLACEMENT

- Loosen the rim holding screw on top and take out the head lamp dome.
- Disconnect electrical connections.
- Thumb push and remove the bulb holding clamp gently.
- Remove the bulb using a clean and soft cloth.

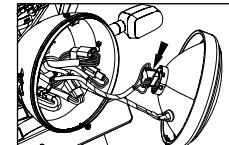
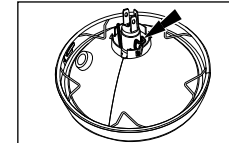
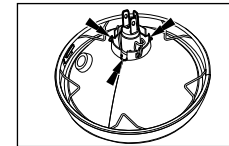

MINOR MAINTENANCE TIPS

- Position the new bulb inside the reflector such that the three projections on the bulb align with the slot on the reflector.
- Refit the bulb holding clamp.
- Connect the electrical connections.
- Position head lamp dome onto the head lamp shell and tighten the mounting screw on top.

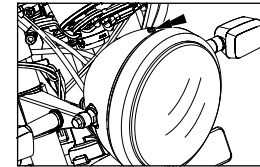

NOTE

Never touch the bulb with your fingers. Finger prints will etch the glass and decrease bulb life apart from causing burns to your fingers.

Always hold the bulb with gloves and clean dry cloth during handling.

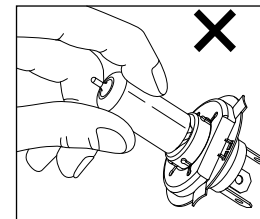

MINOR MAINTENANCE TIPS

TAIL LAMP BULB

- Unlock the side panel RH.
- Remove the seat assembly by pulling seat lock cable.
- Remove the tail light cover by unscrewing its mounting screw.
- Hold the bulb, press inside and rotate anticlockwise to remove the tail light bulb from its holder using a clean cloth.
- Replace the bulb 12V 21 / 5W using a soft clean cloth.
- Re-assemble the tail light in the reverse order of dismantling process.

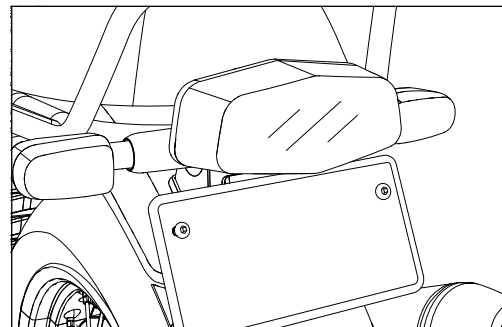

MINOR MAINTENANCE TIPS

TRAFFICATOR BULB REPLACEMENT

- Remove the screw from the trafficator housing.
- Open the indicator housing.
- Remove the bulb holder with help of a screw driver.
- Remove the bulb and replace the same using a soft and clean cloth.
- Refit the holder to its proper position.
- Fix the rubber gasket cover.
- Assemble the indicator housing cover.

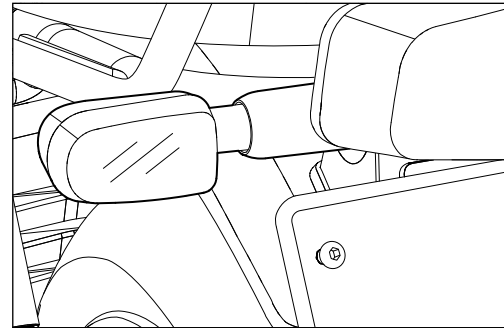

MINOR MAINTENANCE TIPS

MINI BLADE FUSE USAGE LIST

Fuse ID Number	Color	Rating	Remarks
1	V	30 A	Alternator
2	R-W	30 A	Main Fuse
3	G-W	15 A	Ignition Fuse-EFI
4	R	10 A	Signalling Fuse
5	BR	10 A	Horn Fuse

Fuse ID Number	Color	Rating	Remarks
6	R	15 A	Lighting Fuse (Head Lamp)
7	R-W	10 A	Accessory Fuse
8	R	10 A	ABS Fuse
9	R-W	25 A	ABS Fuse

WARNING

Please get the electrical system of your motorcycle checked thoroughly and get the faults corrected immediately after experiencing any fuse failure. Failure to do so may result in repeated fuse failure.

Usage of fuses other than specified rating will damage the complete electrical system.

MINOR MAINTENANCE TIPS

AIR FILTER

CLEAN AND REFIX : EVERY 5000 kms

- Remove the screw from the side panel bottom side and remove side panel.
- Remove the air filter cover screws and then take out air filter box cover.
- Pull out filter element and check for dirt. Clean filter element carefully.

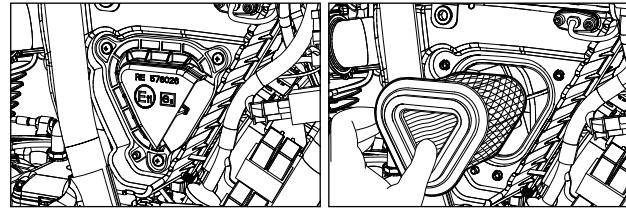

NOTE

Usage of high pressure compressed air is not recommended to clean air filter element.

Fitment of air filter element is in the reverse order of removal process.

LONG TRIP PRECAUTIONS

CHECKS PRIOR TO THE COMMENCEMENT OF A LONG JOURNEY

- Service the motorcycle at Royal Enfield Authorized Service Centre.
 - Ensure sufficient quantity of fuel is always available in the fuel tank for the journey planned.
 - Check and correct Tire pressure if necessary.
-

CHECKS AFTER EVERY 1500 KMS OF RUN

- Any loose fasteners.
- Condition of the Tires.
- Correct oil level in engine.
- Working of all lights and horn.
- Proper drive chain tension.
- Clutch cable free play.

LONG TRIP PRECAUTIONS

ITEMS TO BE CARRIED

- Tools kit.
- Bulbs for headlight, trafficator light and mini blade fuses (10 and 15 A).
- Accelerator and clutch cable.
- Spark plug, spark plug cap.
- Spare tubes.

WASHING PROCEDURE

PRECAUTIONS

- Remove ignition key and seal the ignition key barrel slot using adhesive tape.
- Cover the silencer tail pipe, horn and control switches with suitable plastic bags and tie it firmly to prevent water entry.
- Wash the motorcycle only when the engine is in cold condition.
- Do not remove side panel while washing to avoid water entry.
- Brush engine area with a recommend non corrosive solvent to remove dirt or grease.
- Use low pressure water jet to clean.
- Never spray water with great force on head lamp, meter/cluster unit, flasher lights, front and rear wheel hubs, electrical connections and wires, control cables, EFI components, spark plug, battery, side panels.
- Do not apply any corrosive solvent on painted surfaces or rubber parts.
- Use lukewarm water and mild detergent on the painted components to remove dirt, etc.
- Clean motorcycle thoroughly with plain water to remove the detergent.

WASHING PROCEDURE

- If possible, use compressed air and blow off water particles from the obscure areas of the motorcycle, electrical connections etc.
- Once the motorcycle has been in ride through the salted or near the ocean areas it is recommended to wash your motorcycle with cold water. Please do not use warm water for washing as it may damage the parts the motorcycle due to chemical reaction of the salt. After washing process once the motorcycle comes to complete dry condition it is recommended to apply anti corrosion spray on all the metal and chrome painted areas to prevent the parts from corrosion.

AFTER WASHING

- Ensure, the motorcycle is thoroughly dry by wiping with a clean soft lint free absorbent cloth or chamois leather.
- Remove all adhesive tapes.
- Lubricate control cables, pivots for footrest, side stand, centre stand, brake and gear shifter linkages, drive chain etc. with lube oil.
- Polish the painted and plated surfaces using recommended automobile polishing wax.
- Start the engine and allow to run at an idling speed for a few minutes to warm up engine.
- Drive the motorcycle slowly, apply both the brakes intermittently to dry up the water in brake pads.

STORAGE PRECAUTIONS

In-case your motorcycle is not going to be used for a month or more, the following precautions should be taken.

- Get the motorcycle serviced through a Royal Enfield Authorized Service Centre.
- Drain the fuel completely from the fuel tank and induction system
- Remove spark plug. Pour in about 0.005 quart of clean engine oil through spark plug hole. Close the hole and crank engine several times and refit spark plug.
- Clean drive chain thoroughly and apply Royal Enfield recommended chain lubricant.
- Wipe off excess lubricant after 5 minutes of application
- Remove battery from the motorcycle. Clean the terminals to free from corrosion and apply petroleum jelly to terminals and cover both them using a plastic sheet.
- Store the battery in a cool, dry and well ventilated place.
- Cover the silencer with suitable bags to prevent moisture entry. Set the motorcycle on its centre stand.
- Apply anti rust solutions on all plated parts. Take care not to apply this solution on chrome, rubber or painted parts. Store motorcycle in a clean covered area free of moisture and dust.
- For re-use after storage, it is preferable to get the motorcycle prepared through a Royal Enfield Authorized Service Centre to ensure the motorcycle is restored to its peak operating conditions.

TROUBLE SHOOTING

WARNING

The trouble shooting section of this Owner's Manual is intended solely as a guide for diagnosing problems. Carefully read the appropriate sections of this manual before performing any work, repair and maintenance operations not listed in this Owner's Manual should be performed by your Royal Enfield Authorized Service Centre only. Improper repair / maintenance will result in the motorcycle not functioning properly or serious injury.

WARNING

Please get the electrical system of your motorcycle checked thoroughly and get the faults corrected immediately after experiencing any fuse failure. Failure to comply can result into repeated fuse failures. Usage of fuses other than specified rating will damage the complete electrical system.

CAUSES

REMEDIES

I. ENGINE FAILS TO START

- | | |
|---|-------------------------------|
| 1) Ignition switch in "OFF" position | Turn Ignition switch "ON". |
| 2) Engine kill switch in "OFF" position | Kill switch to "ON" position. |

* Contact Royal Enfield Authorized Service Centre

TROUBLE SHOOTING

CAUSES

REMEDIES

- | | |
|--|---|
| 3) No fuel in fuel tank | Refill fuel. |
| 4) Battery low voltage indicator is glowing continuously | Check battery for voltage / charging circuit. |
| 5) Engine Malfunction indicator is glowing continuously | Get the motorcycle inspected through a Royal Enfield Authorized Service Centre. |
| 6) Spark plug cap / lead not connected | Fix cap / lead firmly. |
| 7) Spark plug electrode dirty / fouled | Clean spark plug |
| 8) Spark plug insulation cracked | Replace spark plug. |
| 9) Main or EFI fuse blown out | Replace with new fuse. |

* Contact Royal Enfield Authorized Service Centre

TROUBLE SHOOTING

CAUSES

REMEDIES

II. ENGINE MISFIRING

- | | |
|---|--|
| 1) Loose spark plug cap | Fix cap firmly. |
| 2) Spark plug fouled | Clean spark plug or non specified heat range plug. |
| 3) Any sensor loose connections | * Check MAP or EOT or TPS sensor wiring / coupler loose connections. |
| 4) Water in fuel tank | * Clean fuel tank. Fill tank with fresh petrol. |
| 5) Engine starts but shuts of immediately | Check if the MIL indicator continuously is glowing; If yes* |
| 6) Engine misfires and runs erratically | Check if the MIL indicator continuously is glowing; If yes* |

* Contact Royal Enfield Authorized Service Centre

TROUBLE SHOOTING

CAUSES

REMEDIES

III. POOR PICKUP

- | | |
|---|---|
| 1) Brake pedal adjusted too tight | *Re-adjust properly, refer to respective section. |
| 2) Choked air filter | Clean / Replace air filter. |
| 3) Drive chain tight | *Re-adjust properly. |
| 4) Under inflated Tires | *Inflate to correct pressure. |
| 5) Accelerator cable free play excessive | Adjust accelerator cable free play. |
| 6) Clutch slipping | *Adjust clutch cable free play. |
| 7) Faulty fuel supply, fuel pump, filter / injector blocked | *Remove fuel pump and clean. |
| 8) Poor pickup | Check if the MIL indicator is glowing; If yes* |

* Contact Royal Enfield Authorized Service Centre

TROUBLE SHOOTING

CAUSES

REMEDIES

IV. ENGINE OVERHEATING

- | | |
|------------------------------|---|
| 1) Low engine oil level | Check and top-up if necessary. |
| 2) Clutch slipping | * Check and correct. |
| 3) Cylinder fins not clogged | Clean the cylinder fins at regular intervals. |

V. EXCESSIVE FUEL CONSUMPTION

- | | |
|-------------------------|---|
| 1) Under inflated Tires | Inflate to correct pressure. |
| 2) Choked air filter | Clean / Replace. |
| 3) Fuel leakage | *Check and rectify, tank float unit, drain pipe, breather pipe, fuel line, pump, EVAP system. |

* Contact Royal Enfield Authorized Service Centre

TROUBLE SHOOTING

CAUSES

REMEDIES

VI. BRAKES POOR

- | | |
|---------------------------------|---|
| 1) Brake pad worn / Uneven wear | *Replace brake pads. |
| 2) Oil / grease on disc. | *Clean and refit. |
| 3) Spongy brake | *Fill brake fluid and perform brake bleeding. |

VII. MOTORCYCLE WOBBLER

- | | |
|-------------------------------|------------------------------|
| 1) Under inflated Tires | Inflate to correct pressure. |
| 2) Loose / Broken spokes | * Tighten / Replace spokes. |
| 3) Wheels misaligned | * Ensure proper alignment. |
| 4) Wheel rim runout | * Rectify. |
| 5) Tires not fitted correctly | * Refit Tires correctly. |

* Contact Royal Enfield Authorized Service Centre

TROUBLE SHOOTING

CAUSES

REMEDIES

VIII. ELECTRICALS

Bulbs do not glow

- | | |
|--------------------------------|---------------------------|
| 1) Bulb fused | * Replace bulb. |
| 2) Fuse blown | * Check and replace fuse. |
| 3) Loose / improper connection | * Check and correct. |

Horn not working

- | | |
|----------------------|--------------------|
| 1) Fuse blown | Check and correct. |
| 2) Loose connections | Check and correct. |

Trafficators not working

- | | |
|---------------------------------|--------------------|
| 1) Loose / improper connections | Check and correct. |
| 2) Bulb fused | Replace. |

* Contact Royal Enfield Authorized Service Centre

TROUBLE SHOOTING

CAUSES

REMEDIES

IX. ELECTRONIC FUEL INJECTION (EFI)

Malfunctioning indicator lamp (MIL) glowing continuously

- | | |
|------------------------------------|---|
| 1) Sensor coupler loose connection | * Check for all EFI sensor coupler loose connection and correct them. |
| 2) Any EFI sensor failure | * Check and replace the same. |

X. ABS (ANTI LOCK BRAKING SYSTEM)

- | | |
|------------------------------------|---|
| 1) ABS indicator continuously "ON" | Take the vehicle to service centre for diagnosis. |
|------------------------------------|---|

* Contact Royal Enfield Authorized Service Centre

MAIN CIRCUIT DIAGRAM

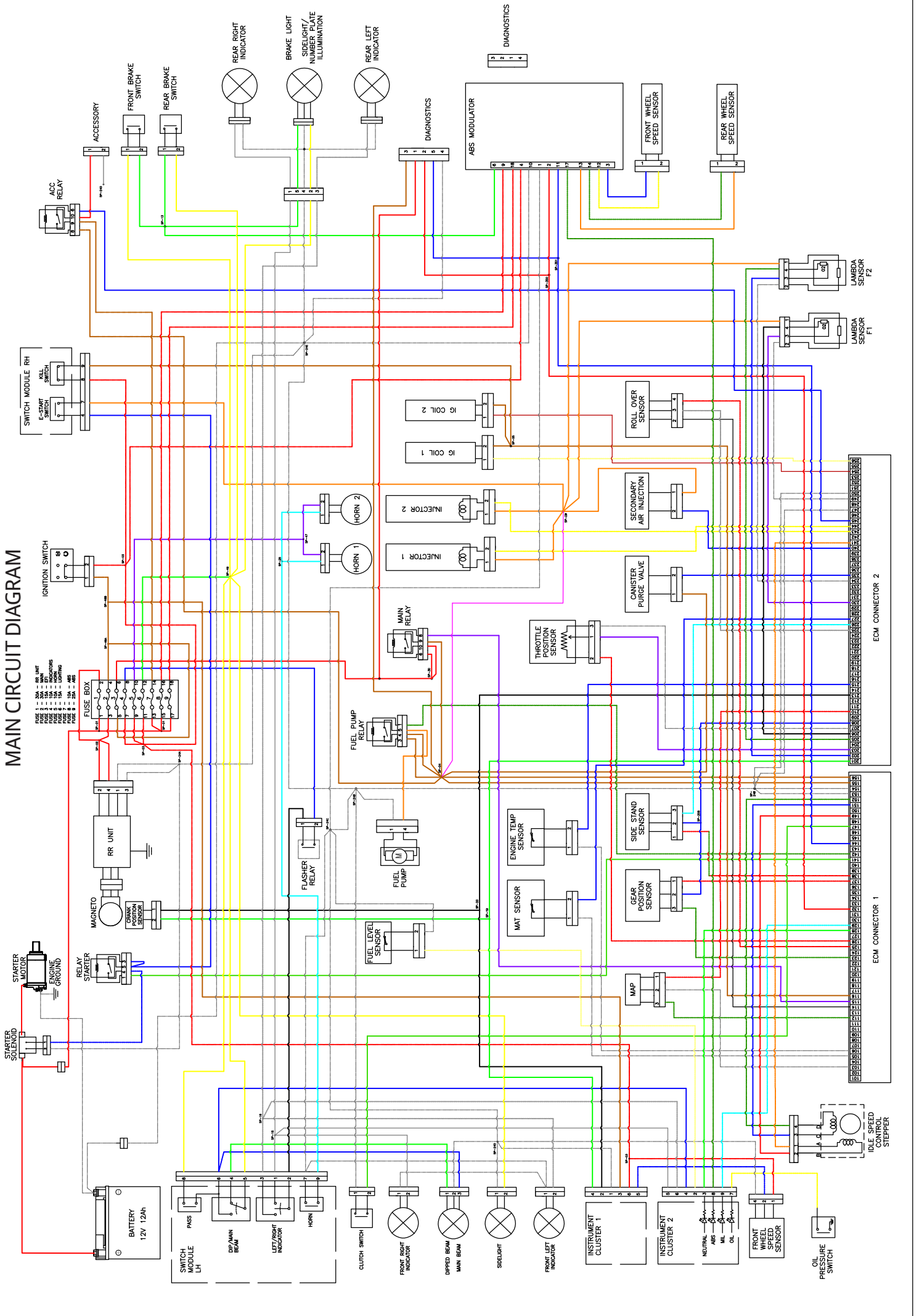

WIRING HARNESS - STARTING SYSTEM

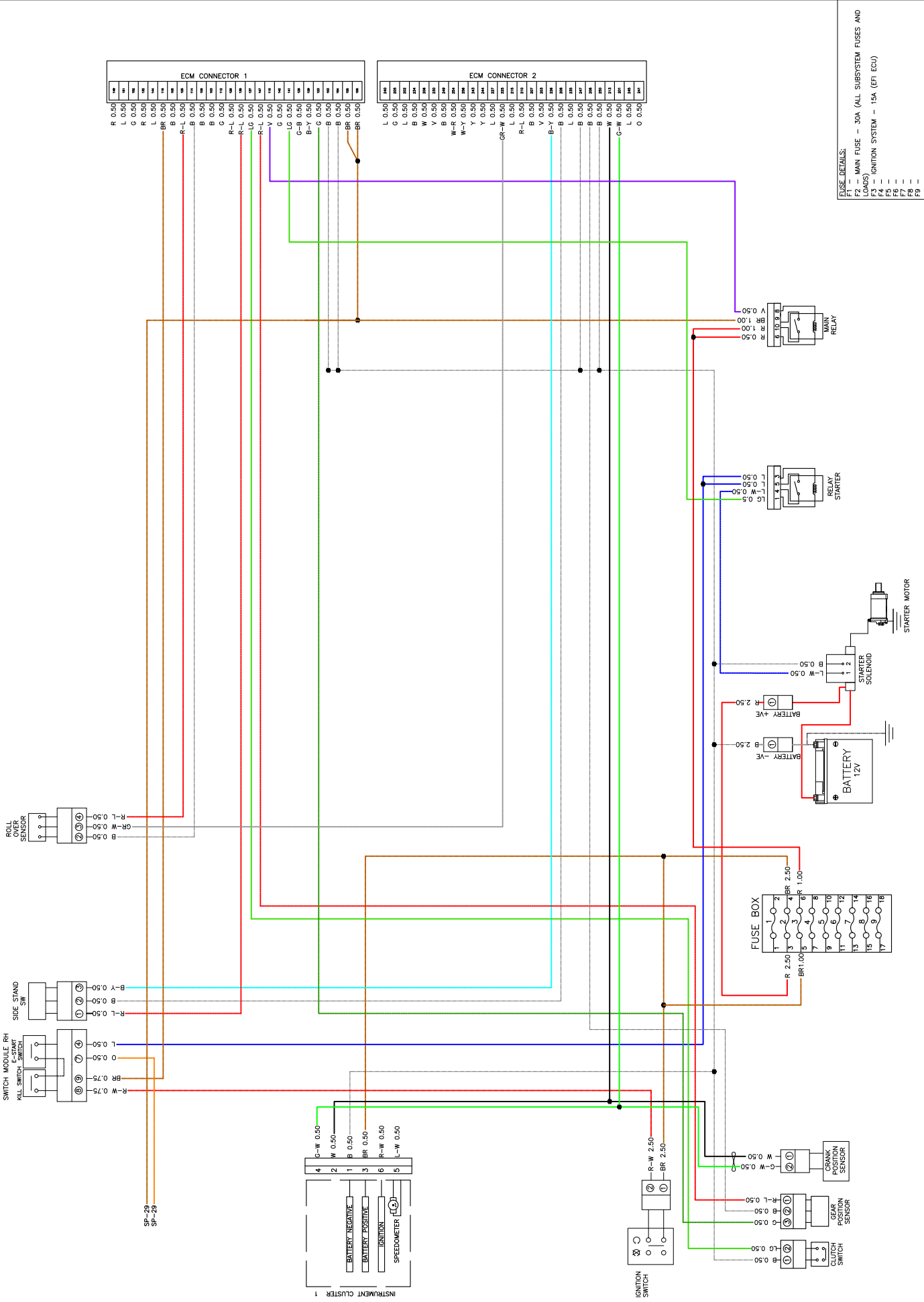

FUSE DETAILS:
 F2 - MAIN FUSE - 30A (ALL SUBSYSTEM FUSES AND LOADS)
 F3 - IGNITION SYSTEM - 15A (EFI ECU)
 F4 -
 F5 -
 F6 -
 F7 -
 F8 -
 F9 -

WIRING HARNESS - STARTING, CHARGING & IGNITION (EFI) SYSTEM

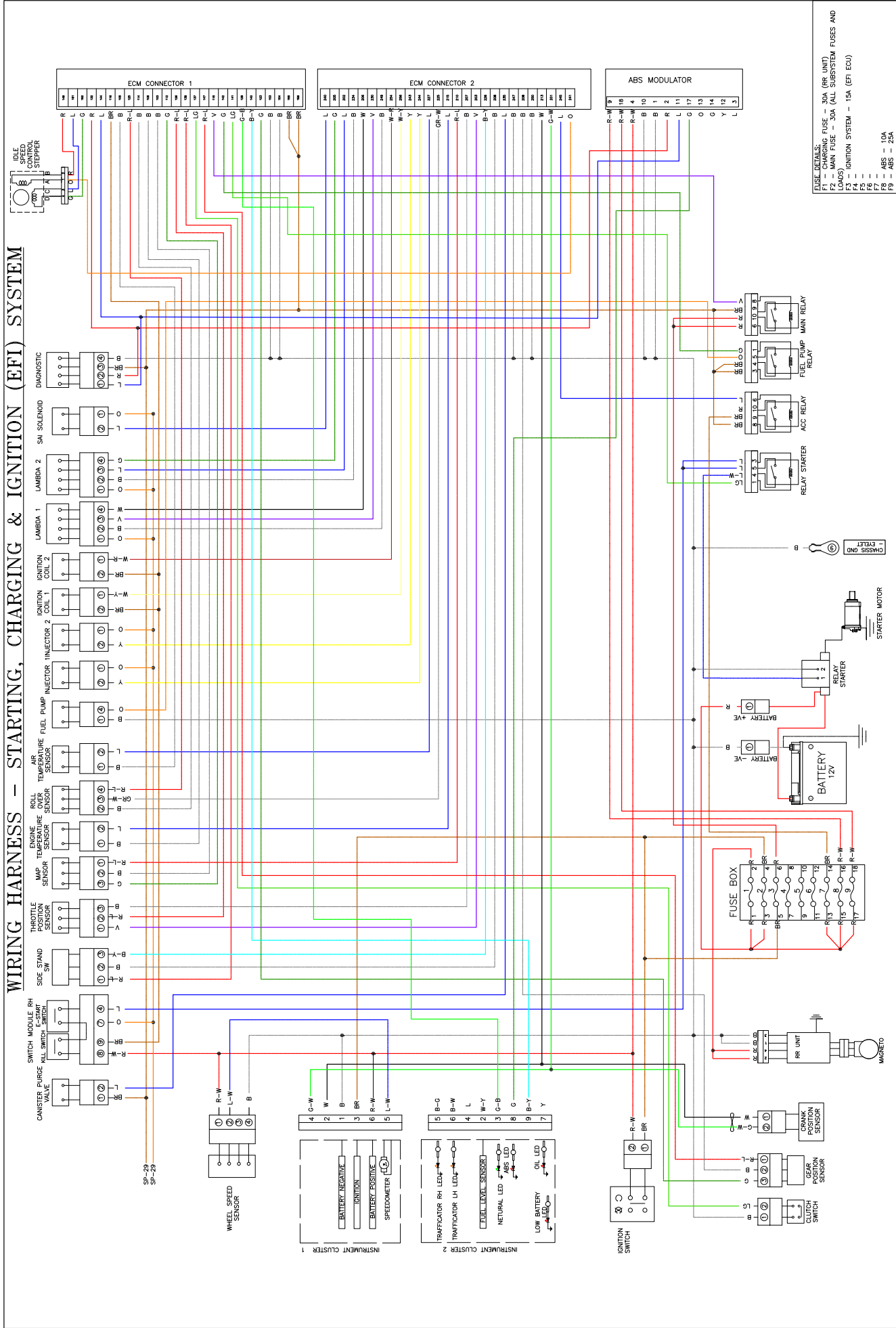

WIRING HARNESS - SIGNALING SYSTEM

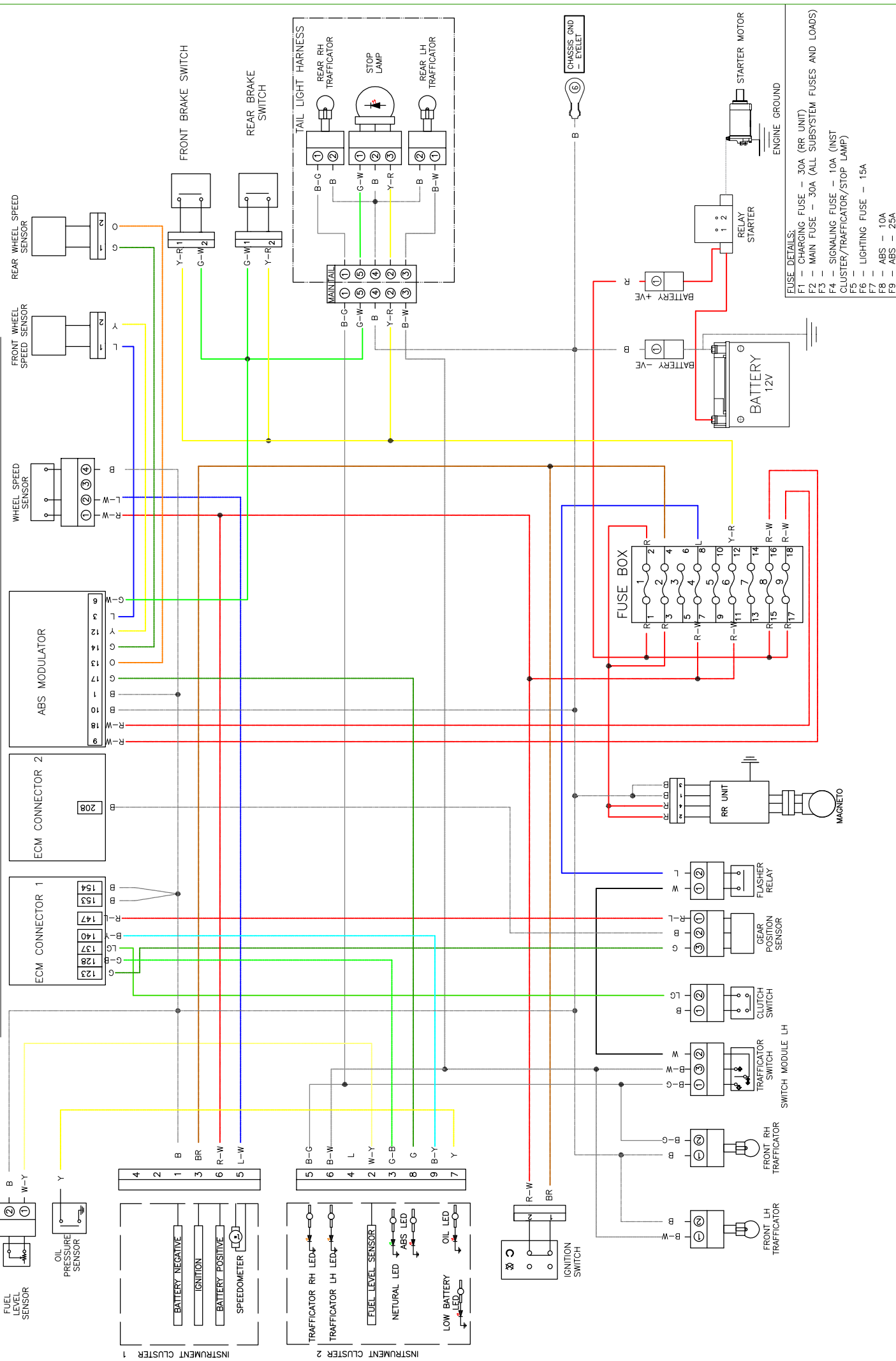

- FUSE DETAILS:**
- F1 - CHARGING FUSE - 30A (RR UNIT)
 - F2 - MAIN FUSE - 30A (ALL SUBSYSTEM FUSES AND LOADS)
 - F3 - SIGNALING FUSE - 10A (INST CLUSTER/TRAFFICATOR/STOP LAMP)
 - F5 - LIGHTING FUSE - 15A
 - F7 - ABS - 10A
 - F9 - ABS - 25A

WIRING HARNESS – LIGHTING SYSTEM

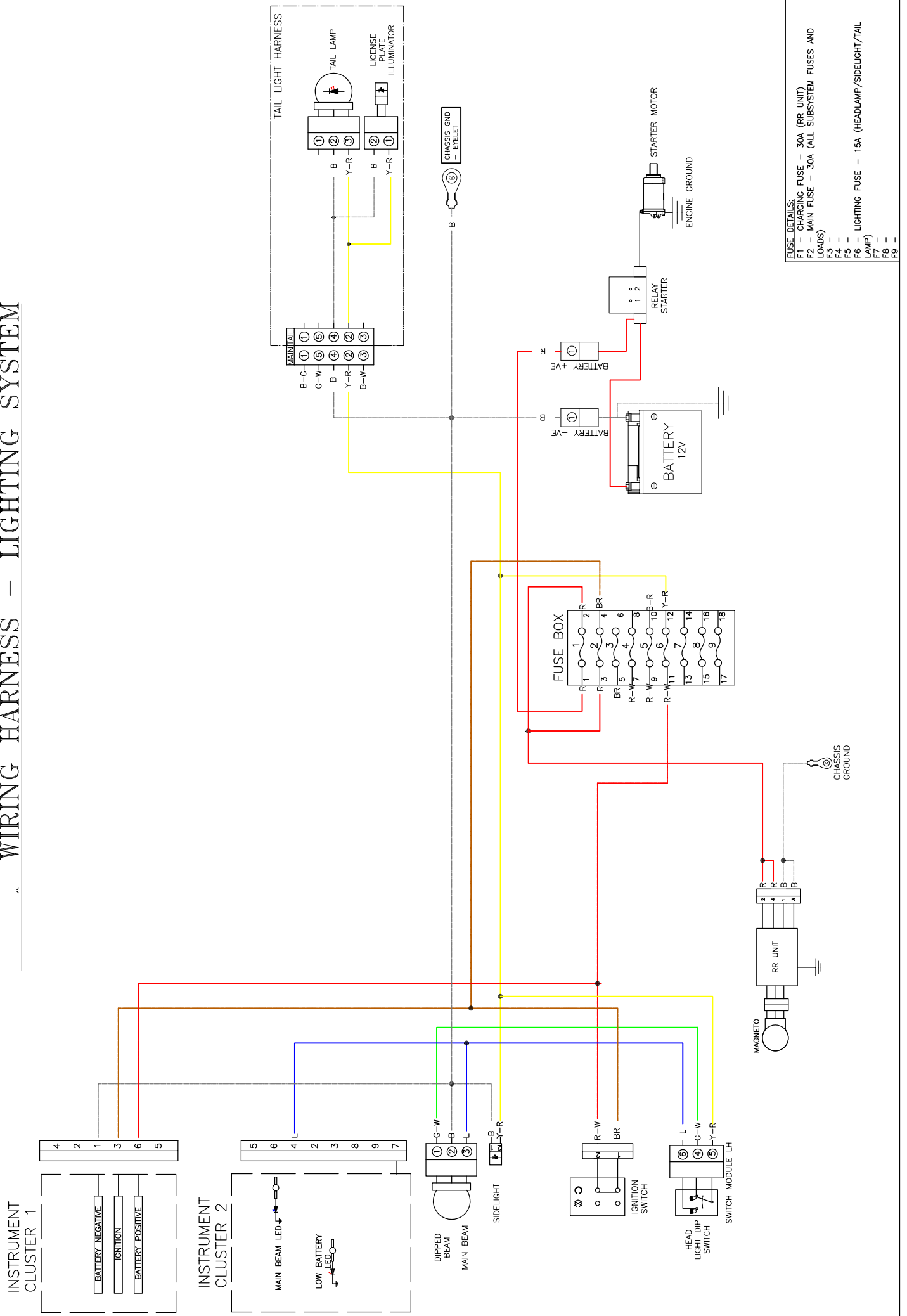

FUSE DETAILS:
 F1 – CHARGING FUSE – 30A (RR UNIT)
 F2 – MAIN FUSE – 30A (ALL SUBSYSTEM FUSES AND LOADS)
 F3 –
 F4 –
 F5 –
 F6 – LIGHTING FUSE – 15A (HEADLAMP/SIDE LIGHT/TAIL LAMP)
 F7 –
 F8 –
 F9 –

WIRING HARNESS - ABS MODULATOR

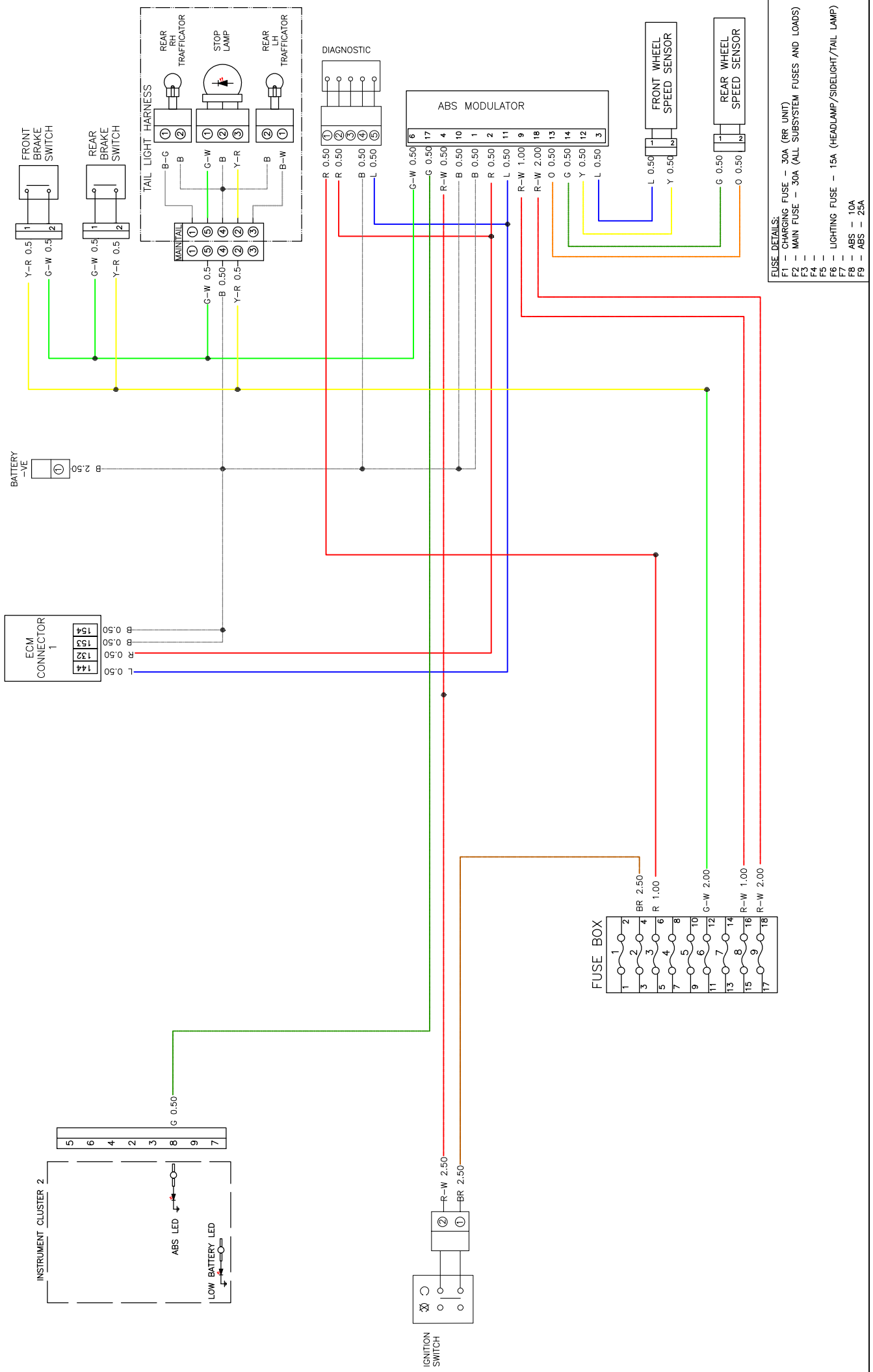

- FUSE DETAILS:**
- F1 - CHARGING FUSE - 30A (RE UNIT)
 - F2 - MAIN FUSE - 30A (ALL SUBSYSTEM FUSES AND LOADS)
 - F3 -
 - F4 -
 - F5 -
 - F6 - LIGHTING FUSE - 15A (HEADLAMP/SIDELIGHT/TAIL LAMP)
 - F7 - ABS - 10A
 - F8 - ABS - 25A
 - F9 -

PERIODICAL MAINTENANCE

The maintenance schedule detailed here will help you to maintain your Continental GT 650 motorcycle meticulously to get a long trouble free service. The schedule provided herein is based upon an average riding conditions and indicates the km/miles at which regular inspections, adjustments, replacements and lubrications are to be carried out. The frequency of the maintenance must be shortened depending upon the severity of the driving condition or if the motorcycle is used in a very dust environment. Contact the nearest Royal Enfield Authorized Service Centre for expert advice and to carry out the required maintenance.

Sl. No.	DESCRIPTION	PERIODIC MAINTENANCE											
		Kms (x 1000)	0.5	5	10	15	20	25	30	35	40	45	50
	Months	1.5	6	12	18	24	30	36	42	48	54	60	
	Miles (x 1000)	0.3	3	6	9	12	15	18	21	24	27	30	
1	Engine Oil (#)	R		R		R		R		R		R	
	Check level at every 1000 Kms or earlier and top up as required												
2	Engine oil filter element (#)	R		R		R		R		R		R	
3	Inlet and Exhaust valve clearance (**)	I		I		I		I		I		I	
4	Spark plug	I	I	I	I	R	I	I	I	R	I	I	
5	HT lead for crack	I	I	I	I	I	I	I	I	I	I	I	

I - Inspect (Clean, Adjust, lubricate or replace if necessary)

L - Lubricate

R - Replace

C - Clean

A - Adjust

(#) - After First service, Engine oil and Engine oil filter replacement is a mandatory at every 12 months even the vehicle has not covered the specified kms.

(**)- After First service, Valve clearance adjustment is a mandatory at every 12 months even the vehicle has not covered the specified kms.

PERIODICAL MAINTENANCE

Sl. No.	DESCRIPTION	PERIODIC MAINTENANCE											
		Kms (x 1000)	5	10	15	20	25	30	35	40	45	50	
	Months	1.5	6	12	18	24	30	36	42	48	54	60	
	Miles (x 1000)	0.3	3	6	9	12	15	18	21	24	27	30	
6	Rubber hose, Air filter to Throttle body	I	I	I	I	I	I	I	I	I	I	I	
7	Rubber hose, Inlet manifold/ Adaptor	I	I	I	I	I	I	I	I	I	I	I	
8	Evaporative Emission Equipment rubber hoses	I	I	I	I	I	I	I	I	I	I	I	
9	Fuel filter - External					R				R			
10	Air filter element	C	C	R	C	R	C	R	C	R	C	R	
		Clean/replace more frequently if operated in dusty condition											
11	Vent Pipe under air filter box	I	I	I	I	I	I	I	I	I	I	I	
12	Hose - Secondary Air	I	I	I	I	I	I	I	I	I	I	I	
13	Accelerator and Throttle pulley cables free play	A	A	A	A	A	A	A	A	A	A	A	
14	Clutch Cable / lever free play	Adjust every 1000 Kms or earlier as required											
15	Hand levers pivot point	Lubricate every 1000 Kms or earlier as required											

I - Inspect (Clean, Adjust, lubricate or replace if necessary)

L - Lubricate

R - Replace

C - Clean

A - Adjust

(#) - After First service, Engine oil and Engine oil filter replacement is a mandatory at every 12 months even the vehicle has not covered the specified kms.

(**)- After First service, Valve clearance adjustment is a mandatory at every 12 months even the vehicle has not covered the specified kms.

PERIODICAL MAINTENANCE

Sl. No.	DESCRIPTION	PERIODIC MAINTENANCE											
		Kms (x 1000)	5	10	15	20	25	30	35	40	45	50	
	Months	1.5	6	12	18	24	30	36	42	48	54	60	
	Miles (x 1000)	0.3	3	6	9	12	15	18	21	24	27	30	
16	Brake pads - Front and Rear	I	I	I	I	I	I	I	I	I	I	I	
17	Disc Brake fluid level - Front and Rear	I	I	I	I	R	I	I	I	R	I	I	
18	Rear brake pedal and Gear change pedal pivot	L	L	L	L	L	L	L	L	L	L	L	
19	Brake hose and Banjo Bolt - Front and Rear	I	I	I	I	I	I	I	I	I	I	I	
20	Front Fork oil leak	I	I	I	I	I	I	I	I	I	I	I	
		Replace oil at every 60000 kms or any work carried out whichever is earlier											
21	Steering taper roller bearing Play	I	I	I	I	I	I	I	I	I	I	I	
22	Rear Wheel Drive Chain	Lubricate and Adjust every 1000 Kms / Clean, Lubricate and Adjust every service or earlier as required											
23	Rear wheel Cush rubbers				I				I				
24	Spokes tightness / Wheel rim run out front and rear	I	I	I	I	I	I	I	I	I	I	I	

I - Inspect (Clean, Adjust, lubricate or replace if necessary)

L - Lubricate

R - Replace

C - Clean

A - Adjust

(#) - After First service, Engine oil and Engine oil filter replacement is a mandatory at every 12 months even the vehicle has not covered the specified kms.

(**) - After First service, Valve clearance adjustment is a mandatory at every 12 months even the vehicle has not covered the specified kms.

PERIODICAL MAINTENANCE

Sl. No.	DESCRIPTION	PERIODIC MAINTENANCE											
		Kms (x 1000)	5	10	15	20	25	30	35	40	45	50	
	Months	1.5	6	12	18	24	30	36	42	48	54	60	
	Miles (x 1000)	0.3	3	6	9	12	15	18	21	24	27	30	
25	Battery terminals (apply petroleum jelly)	C	C	C	C	C	C	C	C	C	C	C	
26	Battery electrolyte levels (Not applicable for sealed battery)	I	I	I	I	I	I	I	I	I	I	I	
27	Earth wire eyelet tightness			I		I		I		I		I	
28	Tire wear pattern front and rear	I	I	I	I	I	I	I	I	I	I	I	
29	Pivot-Side Stand, Centre Stand	L	L	L	L	L	L	L	L	L	L	L	
30	Rider and Pillion Foot rest pivot	L	L	L	L	L	L	L	L	L	L	L	
31	All mounting fasteners in vehicle for tightness	I	I	I	I	I	I	I	I	I	I	I	

I - Inspect (Clean, Adjust, lubricate or replace if necessary)

L - Lubricate

R - Replace

C - Clean

A - Adjust

(#) - After First service, Engine oil and Engine oil filter replacement is a mandatory at every 12 months even the vehicle has not covered the specified kms.

(**)- After First service, Valve clearnace adjustment is a mandatory at every 12 months even the vehicle has not covered the specified kms.

NOTE

For Maintenance after 50,000 Kms, Please repeat the same frequency specified above, in consultation with a Royal Enfield Authorized Dealer / Service Centre.

SERVICE MAINTENANCE RECORD

S.No.	Date	Job Card No.	kms/ miles	Brief details of work / service	Royal Enfield Authorized Dealer
1.					
2.					
3.					
4.					
5.					
6.					
7.					
8.					

SERVICE MAINTENANCE RECORD

S.No.	Date	Job Card No.	kms/ miles	Brief details of work / service	Royal Enfield Authorized Dealer
9.					
10.					
11.					
12.					
13.					
14.					
15.					
16.					

WARRANTY TERMS AND CONDITIONS

Royal Enfield warrants its motorcycle to be free from manufacturing and materials defects, under normal use subject to the following conditions.

1. Warranty shall be in force until the expiry of a period of 36 months from the date of sale. The warranty period begins from the date of retail sales invoice of the motorcycle to the first owner and subsequent owners. The retail invoice date is considered as start date for the warranty period. Once the warranty period has begun, it cannot be stopped or interrupted.
2. In order to effect Warranty, it is a prerequisite that the maintenance schedule prescribed by Royal Enfield in this Owner's manual and warranty repairs if any, has been carried out at the Authorized Distributor's service facility OR at their Authorized dealership's service facility.
3. Record of all the regular services and periodical maintenance that have been carried out, along with proof of service history will be required to be verified by the Authorized Distributor's service facility OR their Authorized dealership's service facility prior to carrying out a warranty service.
4. Proof of Ownership, in the form of Sales Registration OR Proof of Purchase documentation of the motorcycle, clearly mentioning the Engine and VIN numbers, must be provided to the Distributor's service facility OR their Authorized dealership's service facility.
5. During the warranty period, Royal Enfield's obligation is limited to repair or replacing free of charge, such part or parts of the motorcycle which in examination shall be deemed defective in the opinion of Royal Enfield and/or their distributors/ Authorized dealers. Such defective part/s, which has been replaced, shall become the property of Royal Enfield.

WARRANTY TERMS AND CONDITIONS

6. Cost of Consumables like fuel, oils etc, labour, shipping charges of replacement parts for any warranty replacement are chargeable to the customer.
7. Warranty is not applicable for the following parts:
 - Normal ageing of parts like rubber parts, Tires and tubes, hand grips, glass, plastic, soft items like seat rexene, cushion etc.
 - Dullness of chrome plated parts, discolourisation of chromed exhaust pipe / silencer, buffed parts, painted surfaces etc.
 - Normal wear and tear items such as control cables, brake pads/ shoes, clutch plates etc.
 - Electrical items like bulbs, wiring harness, switches, battery, fuses, electric start motor etc.
8. Warranty will become void under the following conditions:
 - Damages due to lack of proper maintenance, periodic services not carried out as per Royal Enfield recommendation etc.
 - Damages caused by any unAuthorized repairs carried out in any part of the motorcycle.
 - Failures occurred due to use of non recommended grade lubricants, fuel or improper level.
 - Use of non genuine Royal Enfield parts.
 - Damages caused due to unAuthorized alterations to any part of the motorcycle.
 - Use of accessories not supplied by Royal Enfield.
 - Motorcycle fitted with side cars.

WARRANTY TERMS AND CONDITIONS

- Motorcycle used in rallies, off road, dirt track, races etc.
 - Motorcycle involved in accidents, collisions etc.
 - Damages that occur due to extreme operating conditions beyond the limitation or specifications as given by Royal Enfield, such as maximum load carrying capacity, engine speed etc.
 - Damages that occur due to long/improper storage, transportation of motorcycle etc.
9. Royal Enfield reserves the right to finally decide on all warranty claims.
 10. Royal Enfield reserves the right to make changes in the motorcycle without any obligation to install these changes on previously sold motorcycle.
 11. Royal Enfield Authorized distributors and /or their dealers are independently owned and operated. They may hence deal with other aftermarket products for which Royal Enfield is not responsible for the performance, safety, quality, reliability and suitability of such products. Defects, if any in such parts OR that may arise in the motorcycle due to use of such parts is not liable to be covered by Royal Enfield and may render this warranty void.
 12. There is no other express OR implied warranty in the motorcycle. Any implied warranty of merchantability or fitness is limited to the duration of this warranty.
 13. To the fullest extent allowed by law, Royal Enfield and its Authorized distributors and/or dealers shall not be liable for loss of use, inconvenience, loss of time, commercial losses or other incidental or consequential damages.

EMISSION CONTROL SYSTEM WARRANTY

The following warranty applies to the emission control system and is in addition to the LIMITED WARRANTY, NOISE CONTROL SYSTEM WARRANTY & CALIFORNIA AIR RESOURCES BOARD REGULATIONS. EVAPORATIVE EMISSION CONTROL SYSTEM WARRANTY. (Applicable only for motorcycles sold within the state of California.)

Royal Enfield Motors warrants the first owner and each subsequent owner, that this motorcycle is designed and built so as to conform, at the time of sale, with applicable regulations specified by the U.S. Federal Environmental Protection Agency and California Air Resources Board Regulations, that the Emission control system related parts fitted to this motorcycle are free from defects in materials and workmanship which may cause this motorcycle not to meet the U.S. Federal Environmental Protection Agency standards for a period of 5 years OR 18,641 Miles (30,000 Kms.), whichever occurs first, from the date of first use of the motorcycle.

The Warranty period shall begin, on the date the motorcycle is delivered to the first retail purchaser OR from the first date the motorcycle is used as a demonstrator OR as a display and/or trial motorcycle.

THE FOLLOWING ITEMS ARE NOT COVERED BY THE EMISSION CONTROL SYSTEM WARRANTY:

1. Failures which may arise as a result of misuse, alterations, accidents OR non performance of routine maintenance, as specified in the Owner's Manual.

EMISSION CONTROL SYSTEM WARRANTY

2. Replacement of parts such as Spark plugs, Air filter, fuel filter, Oil filter, fuel injector, lubricating oils etc that are required to be replaced during routine maintenance at specified intervals as mentioned in this Owner's Manual.
3. Loss of time, inconvenience, loss of motorcycle use or any other consequential loss or damages.
4. Any motorcycle in which the Odometer has been tampered with, OR the speedo cable has been disconnected for any reason Or is broken and not replaced immediately, due to which the exact distance covered cannot be determined.

RECOMMENDATIONS FOR REQUIRED MAINTENANCE

IT IS RECOMMENDED THAT THE ROUTINE MAINTENANCE OF THE MOTORCYCLE BE CARRIED OUT AT SPECIFIED INTERVALS AND ANY MAINTENANCE TO THE EMISSION CONTROL SYSTEMS SHOULD BE PERFORMED ONLY BY AN AUTHORISED ROYAL ENFIELD SERVICE DEALER AND USING ONLY GENUINE ROYAL ENFIELD SPARE PARTS.

REPAIRS TO THE EMISSION CONTROL SYSTEM MAY BE PERFORMED BY ANY OTHER QUALIFIED SERVICE OUTLET OR INDIVIDUAL AND USE OF PARTS OTHER THAN GENUINE ROYAL ENFIELD SUPPLIED PARTS IS PERMISSIBLE, ONLY IF SUCH AGENCY OR INDIVIDUALS AND THE NON GENUINE PARTS USED, ARE CERTIFIED TO COMPLY WITH THE U.S. ENVIRONMENTAL PROTECTION AGENCY STANDARDS.

NOISE CONTROL SYSTEM WARRANTY

The following warranty applies to the noise control system and is in addition to the LIMITED WARRANTY, EMISSION CONTROL SYSTEM WARRANTY & CALIFORNIA AIR RESOURCES BOARD REGULATIONS. EVAPORATIVE EMISSION CONTROL SYSTEM WARRANTY. (Applicable only for motorcycles sold within the state of California.)

Royal Enfield Motors warrants the first owner and each subsequent owner, that this motorcycle is designed and built so as to conform, at the time of sale, with applicable regulations specified by the U.S. Federal Environmental Protection Agency and California Air Resources Board Regulations, that the Noise control system emission related parts fitted to this motorcycle are free from defects in materials and workmanship which may cause this motorcycle not to meet the U.S. Federal Environmental Protection Agency standards for a period of 5 years OR 18,641 Miles (30,000 Kms.), whichever occurs first, from the date of first use of the motorcycle.

The Warranty period shall begin, on the date the motorcycle is delivered to the first retail purchaser OR from the first date the motorcycle is used as a demonstrator OR as a display and/or trial motorcycle.

THE FOLLOWING ITEMS ARE NOT COVERED BY THE NOISE CONTROL SYSTEM WARRANTY:

1. Failures which may arise as a result of misuse, alterations, accidents OR non performance of routine maintenance, as specified in the Owner's Manual.

NOISE CONTROL SYSTEM WARRANTY

2. Replacing OR removing OR modifying any portion of the NOISE CONTROL SYSTEM (consisting of Exhaust, Air intake/cleaner assembly) with parts not certified to be genuine and noise legal in the USA for street use.
3. Loss of time, inconvenience, loss of motorcycle use or any other consequential loss or damages.
4. Any motorcycle in which the Odometer has been tampered with, OR the Speedo cable has been disconnected for any reason or is broken and not replaced immediately, due to which the exact distance covered cannot be determined.

RECOMMENDATIONS FOR REQUIRED MAINTENANCE

IT IS RECOMMENDED THAT THE ROUTINE MAINTENANCE OF THE MOTORCYCLE BE CARRIED OUT AT SPECIFIED INTERVALS AND ANY MAINTENANCE TO THE NOISE CONTROL SYSTEMS SHOULD BE PERFORMED ONLY BY AN AUTHORISED ROYAL ENFIELD SERVICE DEALER AND USING ONLY GENUINE ROYAL ENFIELD SPARE PARTS.

REPAIRS TO THE NOISE CONTROL SYSTEM MAY BE PERFORMED BY ANY OTHER QUALIFIED SERVICE OUTLET OR INDIVIDUAL AND USE OF PARTS OTHER THAN GENUINE ROYAL ENFIELD SUPPLIED PARTS IS PERMISSIBLE, ONLY IF SUCH AGENCY OR INDIVIDUALS AND THE NON GENUINE PARTS USED, ARE CERTIFIED TO COMPLY WITH THE U.S. ENVIRONMENTAL PROTECTION AGENCY STANDARDS.

EVAPORATIVE EMISSION CONTROL SYSTEM WARRANTY

The following warranty applies to the evaporative emission control system.

Royal Enfield Motors warrants the first owner and each subsequent owner, that this motorcycle is designed and built so as to conform, at the time of sale, with applicable regulations specified by the evaporative emission control system related parts fitted to this motorcycle are free from defects in materials and workmanship which may cause this motorcycle not to meet applicable regulations period of 24 Months from the date of first use of the motorcycle.

The Warranty period shall begin either on the date the motorcycle is delivered to the first retail purchaser OR from the first date the motorcycle is used as a demonstrator OR as a display and/or trial motorcycle.

THE FOLLOWING ARE NOT COVERED BY THE EVAPORATIVE EMISSION CONTROL SYSTEM WARRANTY

1. Failures which may arise as a result of misuse, alterations, accidents OR non performance of routine maintenance, as specified in the Owner's Manual.
2. Replacing, removing OR modifying any portion of the EVAPORATIVE EMISSION CONTROL SYSTEM (consisting of fuel tank, fuel tank cap, canister, purge valve, throttle body, vapor hoses, fuel hoses and hose connectors) with parts not certified by Royal Enfield.

EVAPORATIVE EMISSION CONTROL SYSTEM WARRANTY

3. Loss of time, inconvenience, loss of motorcycle use or any other consequential loss or damages.
4. Any motorcycle in which the Odometer has been tampered with OR the speedo cable has been disconnected for any reason OR is broken and not replaced immediately, due to which the exact distance covered cannot be determined.
5. Normal aging of parts such as fuel hoses, vapor hoses, gaskets and rubber components.

RECOMMENDATIONS FOR REQUIRED MAINTENANCE

It is recommended that the routine maintenance of the motorcycle be carried out at specified intervals and any maintenance to the evaporative emission control systems should be performed only by an Authorized Royal Enfield Service Centre and using only genuine Royal Enfield spare parts.

ENVIRONMENT CARE

BE AN ENVIRONMENTALLY CONSCIOUS RIDER

You've ridden through some beautiful places on your Royal Enfield. Won't you like to keep them that way? Here are some tips to help you keep those places unspoilt so that others can enjoy them too:

ENGINE OIL

While your liquid waste like engine oil, gasoline, coolant and other cleaning solvents need to be regularly replaced, what happens to them? Make sure they are not dumped in the soil, down the sewers, drains, lakes or rivers around you. The simplest way to do it is to have them drained into a container which you can hand over to your local recycling agent or at your nearest Royal Enfield Authorized Service Centre. They will follow the guidelines laid down by the local authorities to get rid of it.

BATTERY

If your Royal Enfield's battery needs to be replaced, hand it over to an Authorized recycling agent or Royal Enfield Authorized Service Centre. They will follow the guidelines laid down by the local authorities to get rid of it. This will ensure the dangerous substances from which the battery has been manufactured do not pollute the environment.

ENVIRONMENT CARE

Tire(S)/PLASTIC/ELECTRICAL/ELECTRONIC PARTS/OIL FILTER

If your Royal Enfield's Tire(s)/plastic/electrical/electronic part(s)/oil filter need to be replaced, make sure you hand them over to an Authorized recycling agent or a Royal Enfield Authorized Service Centre. They will follow the local authority's guidelines to get rid of them in an environmentally friendly manner.

CLEANING YOUR ROYAL ENFIELD

Avoid aerosol sprays; instead, use a biodegradable detergent or dry wash to clean your Royal Enfield. Also, be cautious while discarding the cleaning solvents. Hand them over to an Authorized recycling agent or a Royal Enfield Authorized Service Centre. They will follow the local authority's guidelines to get rid of them in an environmentally friendly manner.

This note does not constitute legal advice; please contact your local authorities or your nearest Royal Enfield Authorized Service Centre for further guidance.

NOTES



ROYAL ENFIELD

Part No. RAM00095/A

ROYALENFIELD.COM